

14 Civil Engineering

Synopsis

The FERMI@Elettra project requires the excavation and construction of several new buildings to house the accelerator, FEL's, Experimental area and associated offices and laboratories. These new infrastructures will be furnished and supplied with conventional systems. Furthermore the project will use most of the existing well-established infrastructures at ELETTRA as a development platform. The project will evolve from the existing infra-structure that houses the storage ring linac injector. This will require a physical extension of the present linac tunnel in both upstream and downstream directions, excavation and construction of the FEL and experimental hall. New conventional systems will be provided as will upgrading of the existing ones.

The linac is situated below ground at a depth of ~5 m in a tunnel 110 m long. The linac tunnel will be extended backwards by an additional ~80 m for a total length of 195 m and a surface area of ~750 m². The tunnel will conform to health physics regulations. Adjacent to this backward extension a laboratory area will be built up that will serve for the laser systems used by the Linac. This area, at the same depth as the linac, will also house support laboratories and storage rooms. The control room for the FEL will be situated at ground level approximately midway along the accelerator. The surface building (Klystron gallery) housing the RF power sources and ancillary equipment for the linac will also be extended above the tunnel to the same length.

A large hall, the FEL hall, shielded against the escaping ionizing radiation, will be built below ground as a forward extension of the Linac tunnel and house the beam transport system, diagnostics and undulators with space for future upgrades and additions. It will also house the beam dumps and photon take-off optics leading to the user hall. The FEL hall has an approximate area of 11 by 110 m². Adjacent to the FEL hall and protected by a shielding wall a service gallery will be built that will house equipment for the FELs. In this same location a zone will be dedicated to the seed lasers and another to the pit giving access from ground level to the FEL hall. At the end of the FEL hall the experimental area will be situated, also partially below ground. The experimental zone will be separated from the FEL hall by a 3 m thick shield wall and have a footprint of 60 by 27 m². The land where both the FEL and the experimental hall reside will be excavated and prepared, including modification and upgrade to existing conventional systems. The experimental hall will have two or more floors and surrounding laboratories, including meeting rooms and a small conference centre. This building will have a foot-print of approximately 60 m by 40 m. Careful attention will be paid to building foundations, support structures and the placement of equipment to minimize vibrational disturbance from cultural noise.

The facility requires an upgrade of conventional facilities and the construction of new ones, including a new uninterruptible power supply rated for 600 kW. The uninterruptible unit will guarantee continuous operation of essential main systems, personnel and machine protection systems, accelerator and beamline control systems and vacuum systems. Cooling, heating ventilation and air conditioning will be built to the stringent specifications required for operation. Additional electrical power to a total of ~ 7 MW will be required beyond the present ELETTRA needs. New roads will be built taking into account access to existing infra-structures. Modifications to conventional systems include the re-routing of power cables, gas and water piping and sewage works. Construction and landscaping will conform to all environmental regulations for the protection of local flora and fauna.

14.1 Introduction

The FERMI@Elettra facility will be built inside the ELETTRA Laboratory in the Area Science Park and located in the T8 site situated about one kilometer south-west of the town of Basovizza (Trieste). The site is on the Carso highland near the highway to the Trieste harbour at about 12 kilometers (fifteen minutes by car) from the city of Trieste and thirty kilometers (45 min by car) from the Ronchi dei Legionari Friuli Venezia Giulia international airport. The site has excellent geological characteristics for synchrotron light sources, having a limestone bedrock, that guarantees stability against settling and vibrations.

The main building of the FERMI facility will be developed in a north-west/south-east direction as an extension of the present ELETTRA linac. The FERMI infra-structures will be built both below and above ground. The facility itself is composed of a linac and klystron building, an undulator hall and the experimental hall. A general layout of FERMI infrastructures is shown in site map figure 14.1.1. The site map also shows the location of the storage ring building, within which a new full energy injector is being placed. This new complex composed of a pre-injector linac and booster synchrotron will substitute the linac as main injector.

Buildings for auxiliary plant will also be constructed to house a new electrical station and relative peripheral substations, primary refrigerating plants (cooling towers, refrigerators and fluids) secondary cooling circuit distribution systems (heat exchangers, pumps, demineralising plants), heating system and air conditioning plants (refrigerators, HVACs).

New buildings for offices and laboratories will be constructed, both around the experimental hall and either side of the klystron gallery (ES1 & ES2, see Figure 14.1.1). During the construction phase temporary offices, in the form of pre-fabricated buildings, will be made available (see Figure 14.1.1 for the location) to the project team.

A new road network will also be required that will be optimized for the movement of people, vehicles and equipment around and to the new infra-structure, taking into account access to existing infra-structures (notably the TASC building MM) and construction site limits. The new road consists mainly of an extension of the present network and consists of access, loading areas and parking, as shown in Figure 14.1.1. The new road will avoid the destruction of local flora and fauna and in particular of the trees present inside the Laboratory.

The site of the ELETTRA laboratory is situated near an area that is a type C Site IT3340006 (close to a Community Important Site (CIS) and a Special Protection Zone (SPZ)), as accorded by European

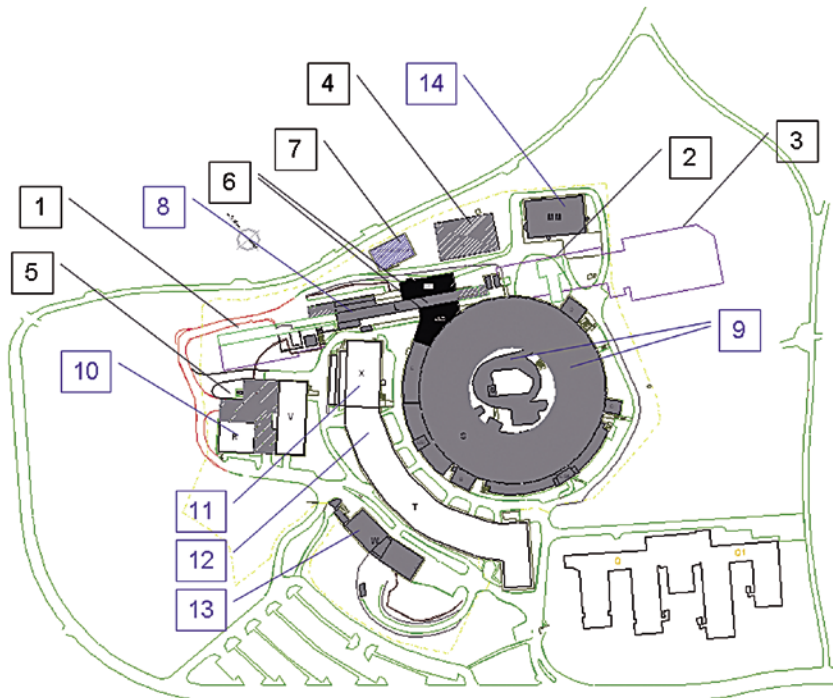

Figure 14.1.1:

General layout of the ELETTRA site showing the footprints of the synchrotron light source and FERMI infrastructures.
NEW FERMI BUILDINGS: 1) Backward extension of the linac building, 2) FEL Hall, 3) Experimental Hall and associated laboratories, offices and meeting rooms, 4) Electrical Plants, 5) Plants Building (cooling towers, refrigerators and chillers, auxiliary plants, etc...), 6) Office and Laboratory Buildings ES1 ed ES2, 7) Temporary Office Building. **EXISTING ELETTRA LABORATORY BUILDINGS:** 8) Linac Building, 9) ELETTRA Storage Ring and Booster, 10) Plants Building (Buildings R (cooling towers, hydrants) e V (refrigerators, boilers, UPS, cogeneration and auxillary plants), 11) Building X (Electrical Plants), 12) Building T1 e T2 (Offices, Laboratories, Meeting Roms, General Services), 13) Building W (Workshop, Stores, Laboratories), 14) Building MM (TASC CNR-INFM Laboratory).

Directives 79/409/CEE and 92/43/CEE, NATURE 2000 NET. Although the the border of the FERMI laboratory is not within Site IT334006, a study of environmental impact has been performed for the project that takes into consideration the geology and the geomorphology of the area, in addition to aspects of impact to local flora, fauna and vegetation. FERMI will be developed taking into account all external factors and will minimize the effects on the environment.

14.2 Buildings

This section describes the principal characteristics of the FERMI@Elettra facility buildings. The FERMI main buildings are a series of structures that will house the main FEL components, notably the linac, FEL's and experimental hall. Buildings for auxiliary and conventional plants are structures in which the electrical, water and HVAC systems will be installed. Buildings will also be provided for support and sample preparation laboratories, office and meeting rooms. An artists impression of the surface buildings is shown in figure Figure 14.2.1. The underground layout of the buildings is shown in Figure 14.2.2.

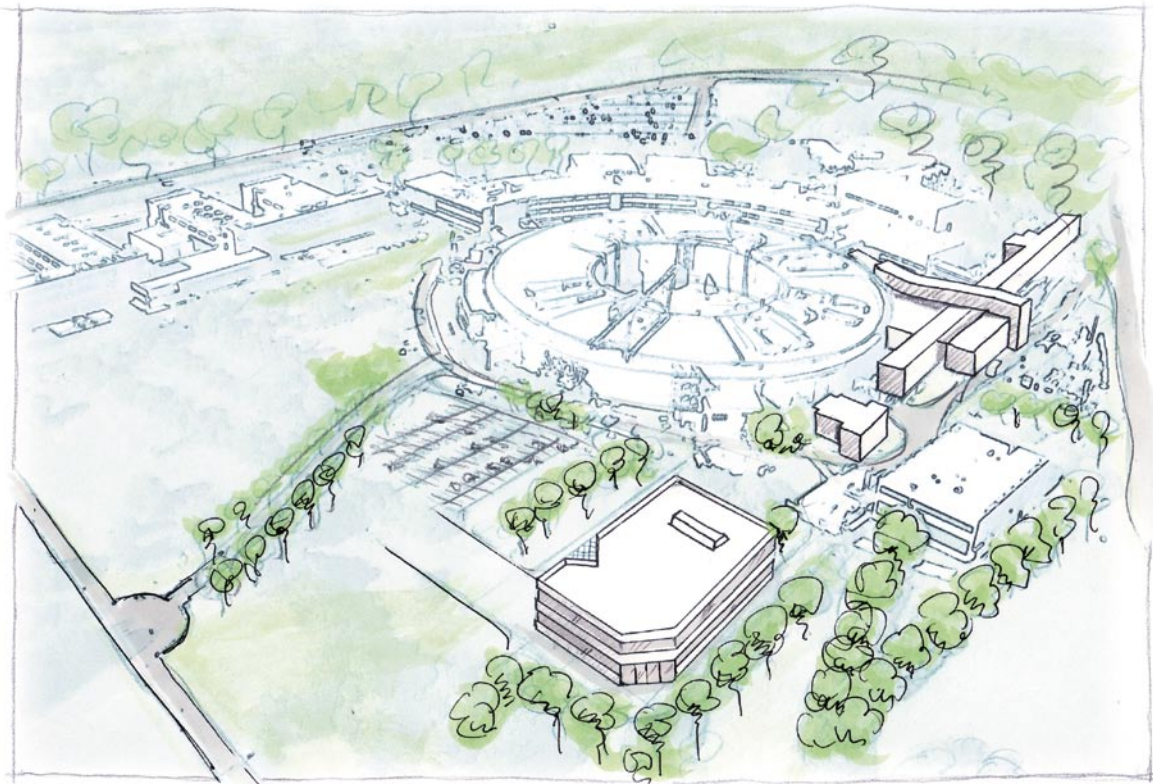

Figure 14.2.1:
Artists impression of FERMI surface buildings. From right to left the backward and forward extension of the linac klystron gallery, access building for the FEL hall and the experimental hall.

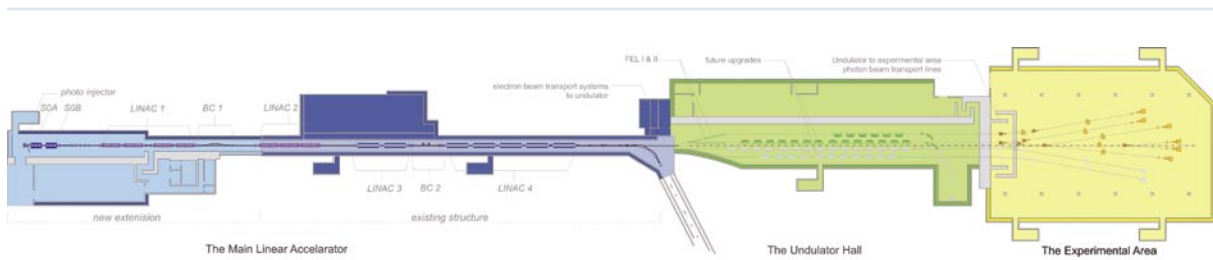

Figure 14.2.2:
Overall underground layout of FERMI showing the backward extension of the linac tunnel, the existing linac tunnel, the FEL hall and the Experimental Hall.

14.2.1 Linac Building

A schematic of the Linac building is shown in figure Figure 14.2.3. This building is composed of an underground tunnel containing the linac and a surface klystron gallery housing power sources for the linear accelerator and support equipment. The present klystron gallery will be extended both in the backward and forward direction and will house the new plants for the new linac injector and the relocated RF plants (Figure 14.2.3(a)). The linac tunnel will be extended in the backward direction by ~80 m to accommodate the photo-injector, the laser heater and the first bunch compressor. Adjacent to the new tunnel extension an underground hall will also be built that is laterally shielded and will house the photocathode laser, test and assembly rooms. The complete tunnel and surface building will have a length of approximately 195 m.

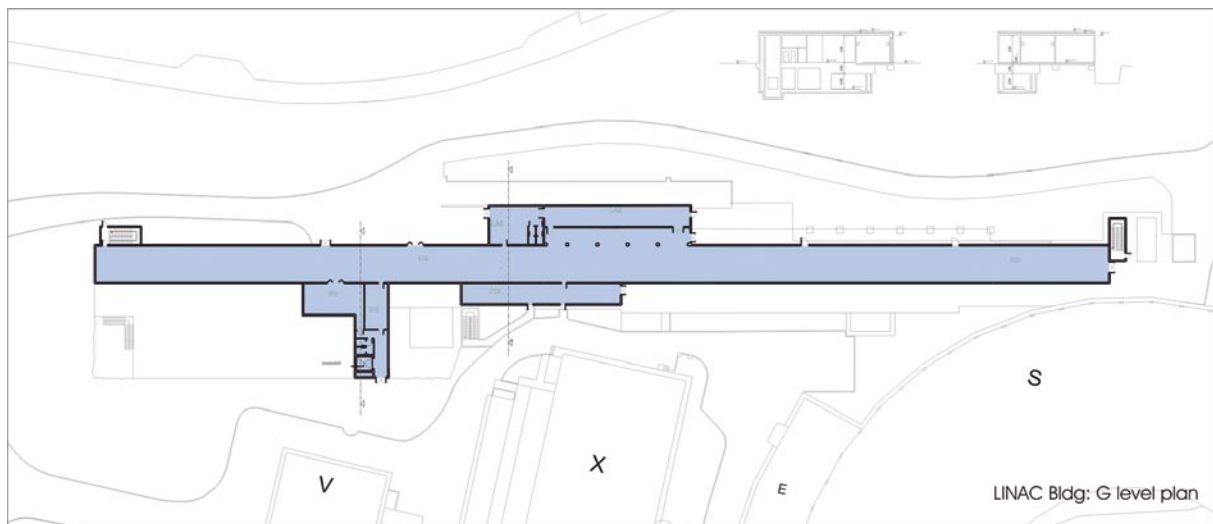

Figure 14.2.3(a):
LINAC Building. Linac surface buildings. Klystron gallery, Control room and support laboratories.

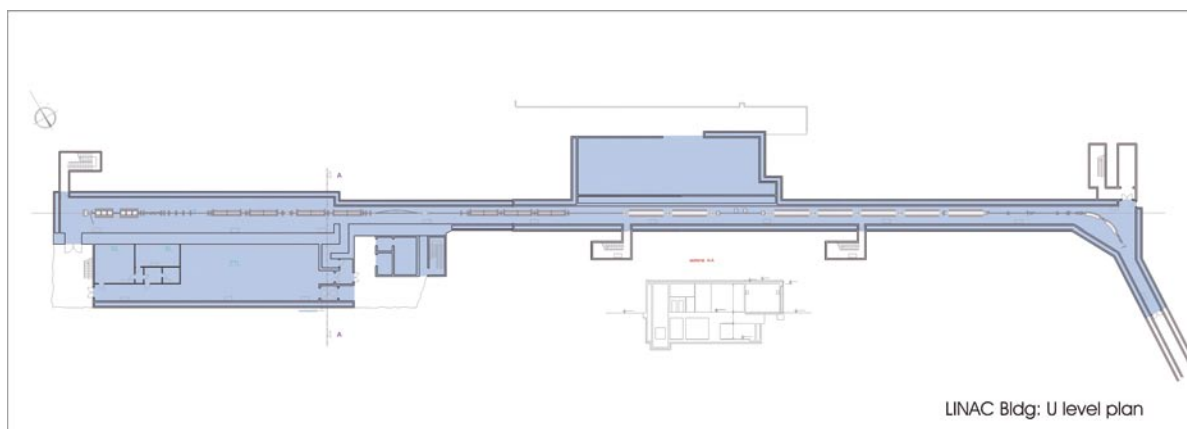

Figure 14.2.3(b):
LINAC Building.
 Underground tunnels and halls. Linac tunnel, photocathode laser hall, assembly and support rooms.

In a manner similar to the existing linac building, the new building will be divided into different functional zones:

- a) An underground gallery, extending to the FEL hall, will house the photoinjector, injector and main linear accelerator including diagnostics and safety systems.
- b) Adjacent to the tunnel housing the linac injector a service gallery will contain the laser room for the photocathode laser, an optical laboratory, assembly rooms and store rooms. The temperature of the laser room will be regulated to $\pm 0.5^{\circ}\text{C}$. Ventilation and air conditioning of the hall will have specifications guaranteeing low dust contamination. The room will also be isolated from vibrations.
- c) Surface buildings (co-linear to the tunnel) will house the high power RF plants and electrical auxiliary systems for the linac sections and photocathode electron gun. These buildings will be an extension of the present klystron gallery and will be similarly off-set with respect to the linac tunnel, permitting correct access of the waveguides feeding the linac sections with power. The klystron gallery will be extended backwards by ~ 80 m and forwards by ~ 20 m to an overall length of ~ 195 m. An extension will also be made of the crane that has a capacity of 5000 kg.
- d) A surface building will be dedicated to the control room, laboratories and a store room. The control room will be positioned in proximity of the present one.
- e) The existing water substation building attached to the klystron gallery, that houses part of the cooling system, will be doubled to room the new cooling plants.

The sides (not flanking bed-rock) and ceiling of the linac tunnel will be constructed to shield against the escape of ionizing radiation and will conform to European radiation protection regulations. A sufficient number of emergency exits will be provided conforming to safety regulations. Access to the tunnel will be through chicanes dimensioned to inhibit propagation of scattered radiation and conforming to emergency service specifications.

At the upstream end of the linac tunnel an access pit will be used for the transportation of heavy machine components, such as accelerating sections and magnets. These will be lowered into the pit and moved into the linac tunnel through a shield door. A monorail crane will be used to transport equipment in the tunnel. The existing crane with a capacity of 3000 kg will be extended into the new tunnel.

14.2.2 Undulator Hall

At the downstream end of the linac building, at the same level as the linac tunnel, the FEL hall will be built. The hall will house the beam transport system from the linac to the undulator chains composing the FELs, the beam dump systems and the take off optics. The dimensions of this hall are approximately 110 by 11 m² with a height of 3.5 m (see Figure 14.2.4). Parallel to the FEL hall a service gallery will house ancillary equipment. The tunnel will have a roof of concrete 2 m thick to stop ionizing radiation reaching the outside. Similarly the wall separating the FEL hall from its adjacent service gallery will have a 2 m thick wall. This will permit access to the service gallery during operation for maintenance and control. The possibility of placing the service gallery on the surface above the FEL hall will also be evaluated during the detailed design phase.

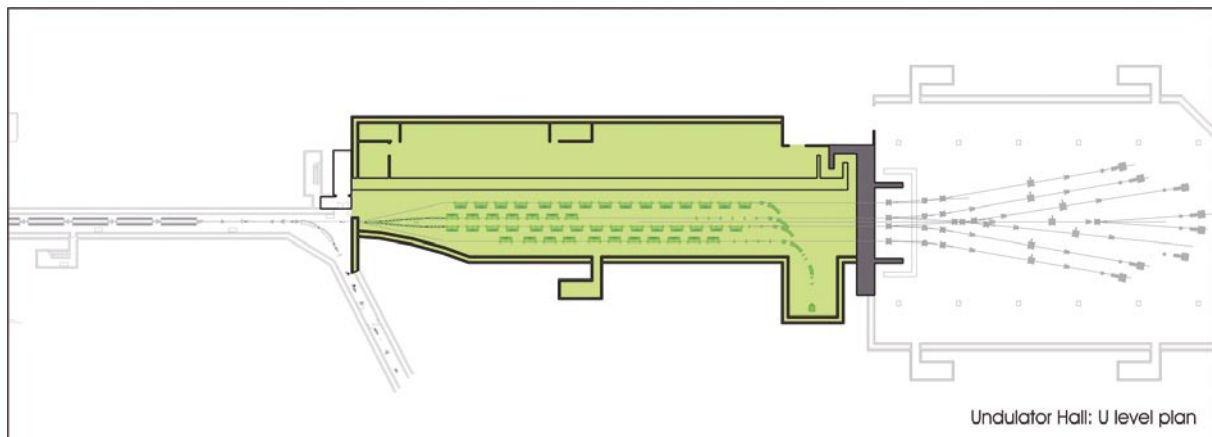

Figure 14.2.4:
Plan view of the FEL Hall.

In the tunnel two chains of undulators and associated equipment will be installed constituting FEL-1 and FEL-2. Leading to the undulators from the end of the linac, a beam transfer line, composed of magnets, vacuum chamber and diagnostic equipment will be assembled. In parallel to the two foreseen undulator chains, space will be left for additional undulators for future developments and upgrades

(Figure 14.2.4 shows space for four undulator chains). The “spent” electron beam exiting the FELs will be deflected to a side enclosure and channeled into a beam dump. This area will be shielded against the escape of ionizing radiation by the surrounding rocks and a 2 m thick concrete roof.

At the end of the FEL hall a 3 m thick concrete wall will separate it from the experimental hall. The photon beams generated in the undulator chains will pass through holes in this wall and impinge onto deflecting mirrors. The electron beam will never reach this wall, having been deflected to the beam dump in the side enclosure. Both passive and active fail-safe systems will be used to guarantee the impossibility of the electron beam ever reaching the end wall. The front ends, composed of gas chambers and delay lines and diagnostics, will be situated within the FEL hall, just prior to reaching the end wall.

At the start of the FEL service gallery, a clean room isolated against vibrations will house the Seed Laser. This room will be thermally controlled to better than ± 0.5 °C. Along the rest of the service area gallery, electrical equipment and control racks will be installed. A sufficient number of emergency exits conforming to safety regulations will be provided, both to the FEL hall and away from the service gallery to the open. Access to the FEL hall will be through chicanes that will satisfy safety regulations for space and access. The option of placing the seed laser room on the surface at the end of the klystron gallery will be evaluated during the detailed design phase.

At surface level an access building will be constructed above an opening to the FEL hall. This building will be sufficiently large to allow the access of a transportation truck and will mount a crane used to lower equipment into the FEL hall. During operation of the facility the opening to the FEL hall will be closed with shield blocks conforming to radiation safety requirements.

14.2.3 Experimental Hall

The experimental hall will be situated at the end of the FEL hall, see Figure 14.2.6. Separating the two halls will be a 3 m shield wall. Just after the shield wall, and within the experimental hall, a mirror room

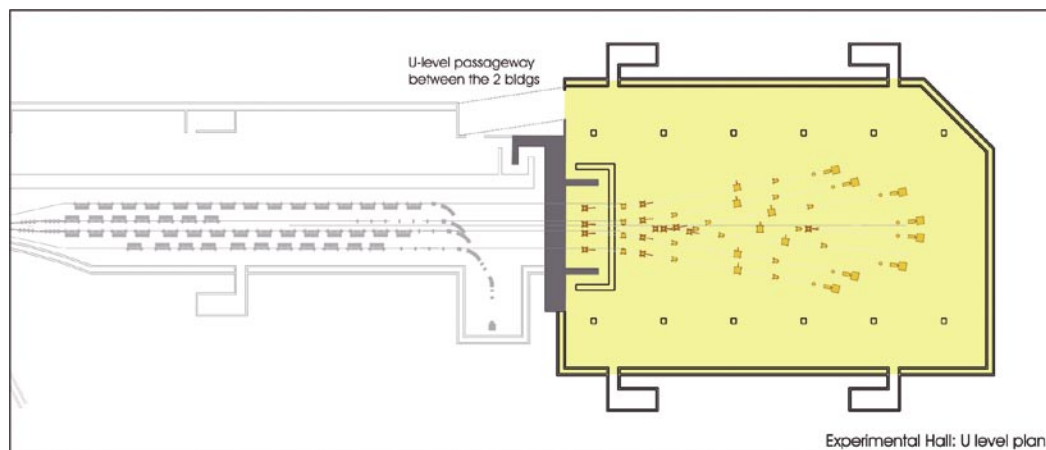

Figure 14.2.5:
Plan view of the Experimental Hall.

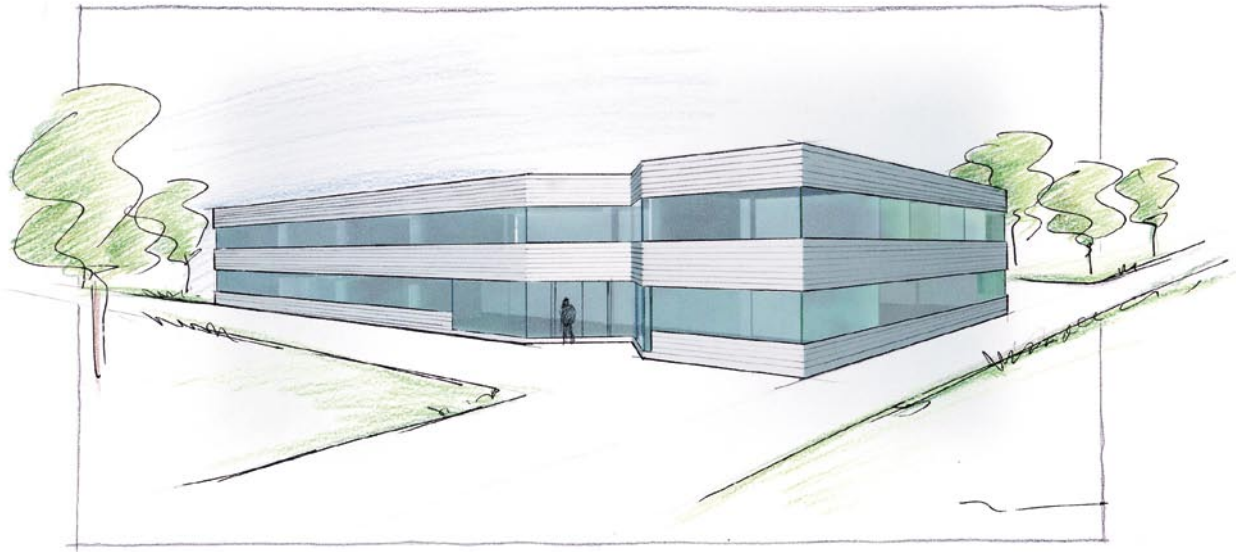

Figure 14.2.6:
The Experimental Hall.

will be built. This room will be separated from the Experimental hall proper by a 0.8 m thick wall. The mirror room will house the first deflecting mirrors. The roof of the mirror room will be sufficiently thick to shield against the escape of ionizing radiation. The FEL photon beams, after being deflected by the mirrors, will be transported through beamlines by additional optics to experimental end stations. The beamlines are approximately 50 m in length and are positioned 1.3 m from floor level.

The Experimental hall will be dimensioned to allow installation of up to 10 beamlines and accompanying end stations (60 m by 27 m wide, a height of 8 m and a floor area of roughly 1620 m²). A 7000 kg bridge crane will access the experimental floor area at a height of 6 m.

Support laboratories will be built on either side of the Experimental hall. The Experimental building will have three floors, including the beamline area and will be approximately 60 m long by 40 m wide. The upper floors will be used for offices, meeting rooms and storage space. An artists view of the building above ground is shown in Figure 14.2.6.

Transportation of equipment to the Experimental hall will be via a sloping road accessing the lower level of the building. This road will permit the movement of heavy or bulky components to a loading area. The Experimental hall bridge crane will then be used to transport this material into and around the hall. A sufficient number of emergency exits conforming to regulations will be provided.

14.2.4 Conventional Installations

The principal infrastructures necessary for conventional installations and auxiliary plants are an electric main station, a cooling tower facility and a water plant building housing pumps and piping, as indicated in the general layout Figure 14.1.1.

14.2.4.1 Main Electric Station

On the north-east side of the site, a building on two floors housing the main electric station will be constructed with a foot-print of 25 m by 40 m. A new electric cabinet will take power from the main electric line of the local electrical supplier ACEGAS-APS. The principal distribution system for Sincrotrone Trieste will be housed in this building. A metal clad switching system will be used to supply medium voltage power to peripheries and transformers. Uninterruptible power supplies will have their own room. The building will also house all subsystems to power the storage ring, linac, FEL hall, Experimental hall and laboratories of the AREA di Ricerca.

14.2.4.2 Cooling and Water Facilities

In the area between the present cooling tower facility and the heating/refrigeration plant, as shown in the general layout Figure 14.1.1, a new building (900 m²) will be erected containing conventional installations, heating and cooling plants, the compressed air station and other technological plants. The FERMI facility requires a cooling system that is described in detail below. The existing cooling tower will be upgraded and new plants installed. Peripheral local substations will provide heating and ventilation.

14.2.4.3 Office and Laboratory Buildings

Two buildings either side of the klystron gallery (ES1, ES2 and temporary pre-fabricated buildings, see Figure 14.1.1), will provide office, laboratory and storage space for FERMI project personnel.

14.2.4.4 Prefabricated Building

This will be a provisional prefabricated building installed in the north-east area as shown in Figure 14.1.1. The building will permit 50 work places with meeting rooms.

14.2.4.5 ES1 and ES2 Building

On either side of the klystron gallery and close to the storage ring building two new office and laboratory buildings (ES1 and ES2) will be erected having two floors. The ground floor will be arranged and serviced to house laboratories. The area on the first floors will be mainly reserved for offices.

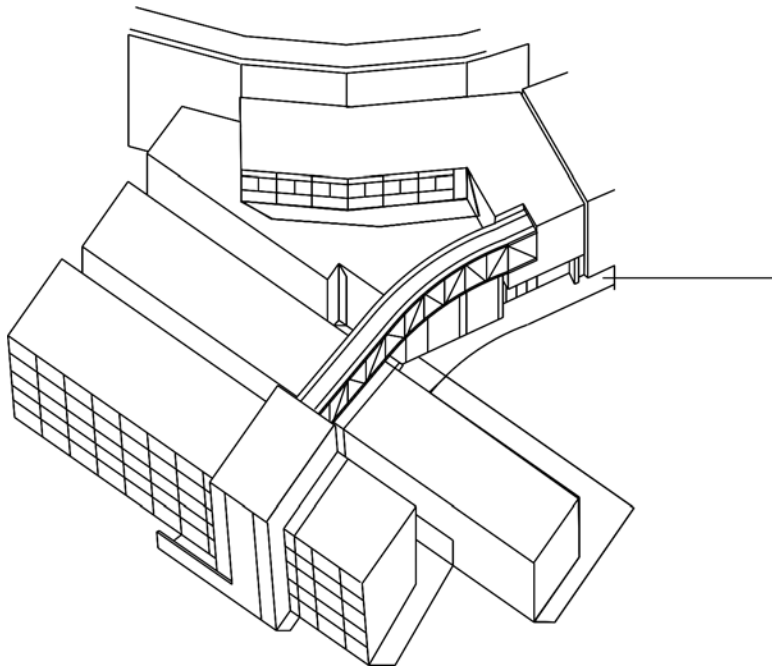

a) Schematic view of buildings ES1 and ES2 either side of the klystron gallery. An access bridge crossing the klystron gallery will connect the two buildings. ES2 is located between the storage ring building and the klystron gallery.

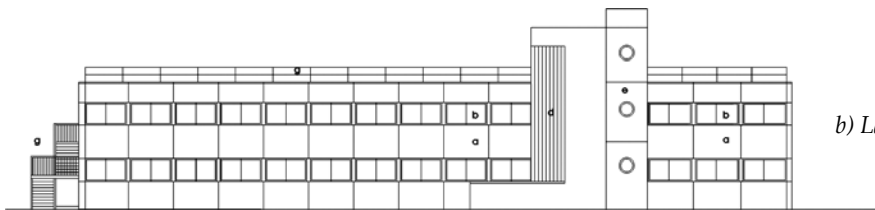

b) Lateral view of building ES1

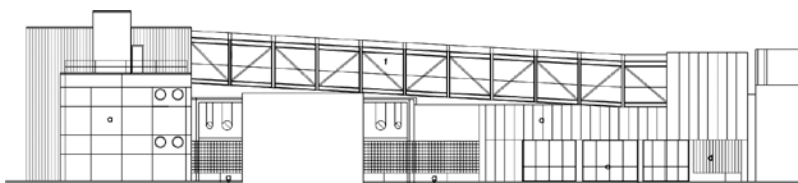

c) Cross-sectional view of buildings ES1 and ES2.

Figure 14.2.7:
Schematic views of office and laboratory buildings ES1 and ES2.

14.3 Auxiliary Plants

14.3.1 Electrical Power System

The FERMI electrical power system is outlined in Figure 14.3.1 and its main parameters are summarized in Table 14.3.1.

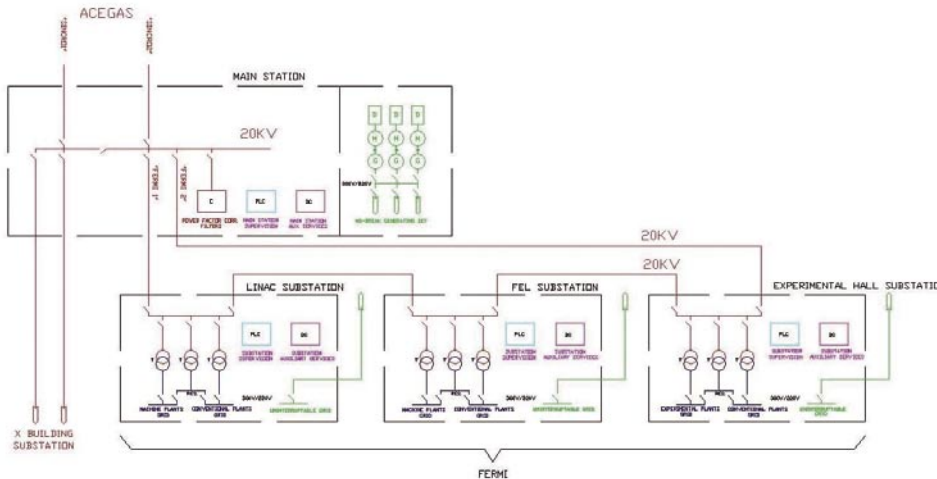

Figure 14.3.1
Electrical Power System scheme.

The electric plant is composed of a new electrical station taking power from the main line of the supplier ACEGAS-AS. The station will be powered from existing 20 kV cables. The total power used will be 12 MW. Parameters of the medium voltage systems are given in the following table.

Table 14.3.1: Electrical Power System Parameters.

Nominal Voltage	20 kV	± 10%
Nominal Frequency	50 Hz	± 1% (95% year) [+4% – 6%] 100% year
Three phase current	11.5 kA	
Neutral		Isolated
Medium Voltage System		IT
Fault current towards earth	32A	
Reaction time towards an earth fault	< 0.6s	

14.3.1.1 Main Distribution

From the ACEGAS electrical station the two existing 20 kV incoming lines will be connected to the new metal clad cabinet in the main electrical building. This building also houses harmonic filters and re-phasing systems. From the metal clad cabinet new 20 kV electrical lines will supply the existing ELETTRA metal clad cabinet, situated in building X (see site map Figure 14.1.1), that is connected to the Sincrotrone Trieste and Area di Ricerca Facilities. This will handle the present total power of 5 MW and that of the FERMI systems (linac, FEL, Experimental building and auxiliary plants) for a total power of 7 MW. The drop in voltage will be compensated since an excessive drop will have an adverse effect on the functioning of plants. The systems will be powered via a low voltage line, the parameters of which are given in Table 14.3.2 below.

Table 14.3.2: Electrical Parameters of the Medium Voltage plant.

Nominal Voltage:	400 V / 230V
Nominal Frequency	50 Hz
Neutral	Earthed
Low Voltage System	TN-s
Reaction time towards an earth fault	< 0.4s
Voltage Drop	< 4%

14.3.1.2 Electric Substations

The FERMI Substation will be installed in a central position with respect to the principal FERMI facility buildings to optimize the low voltage supply of power. The substation will have room for 20 kV/0.4 kV transformers and the relative power centres that will supply the various electrical racks of the linac, FELs, beamlines and experimental stations and associated conventional systems. All main and secondary electrical stations will be connected via a cabled network using underground or suspended conduits.

14.3.1.3 Emergency and Uninterruptible Power System

An emergency and uninterruptible power supply will be housed in the main electric building. The system is presently composed of three 400 kVA rotating electric groups each connected through a flywheel/ friction system to a diesel engine that starts when the main external supply is interrupted. A fourth group will be installed to cover the uninterruptible power needs of the FERMI facility.

A dedicated distribution circuit will start from the power center supplied by these groups. The electrical parameters of this circuit are given in table 14.3.3. The drop in voltage will be compensated since an excessive drop will have an adverse effect on the functioning of systems.

Table 14.3.3: Electrical Parameters of the low voltage uninterruptible plant.

Nominal Voltage	400 V / 230V
Nominal Frequency	50 Hz
Neutral	Earthed
Low Voltage System	TN-s
Reaction time towards an earth fault	< 0.4s
Continuity	Absolute
Voltage Drop	< 4%

14.3.1.4 Normal and Emergency Illumination Plants

All new buildings will be equipped with normal and emergency lighting. Particular attention will be given to energy saving strategies that adopt presently available technologies as foreseen in the European project GreenLight with which Sincrotrone Trieste is associated.

Emergency lights will conform to safety regulations; they will be of the self-powered type and will guarantee illumination of escape exits. Luminous panels will indicate the shortest access routes to emergency exits.

14.3.1.5 Energy Saving Policy

According to the energy saving policy of Sincrotrone Trieste electrical equipment will be preferentially chosen that is energy efficient. A complementary electrical plant producing a limited quantity of electrical power will also be used. The design of the complete electrical system will be optimized to maximize energy savings.

14.3.1.6 Earthing and Protection against Lightning

A new electrical grounding network will be constructed for FERMI that will take into account the existing system. The present system is not homogeneous and is composed of connected electro-welded webs, rods and dispersion plates. The composition of the terrain is Carsic rock (limestone) with a average electrical resistance of 3 kOhms/m. The equivalent dimensions of the grounding network is 350 m and provides a low earth resistance of 4.29 Ohms and a worst case voltage drop of 2 Volts.

All buildings will adopt lightning rods or arrays for protection against atmospheric electrical discharges that conform to safety regulations.

14.3.2 Cooling Systems

Cooling circuits and chiller plants for the facility are schematically outlined in Figure 14.3.2 and main parameters given in Table 14.3.2.

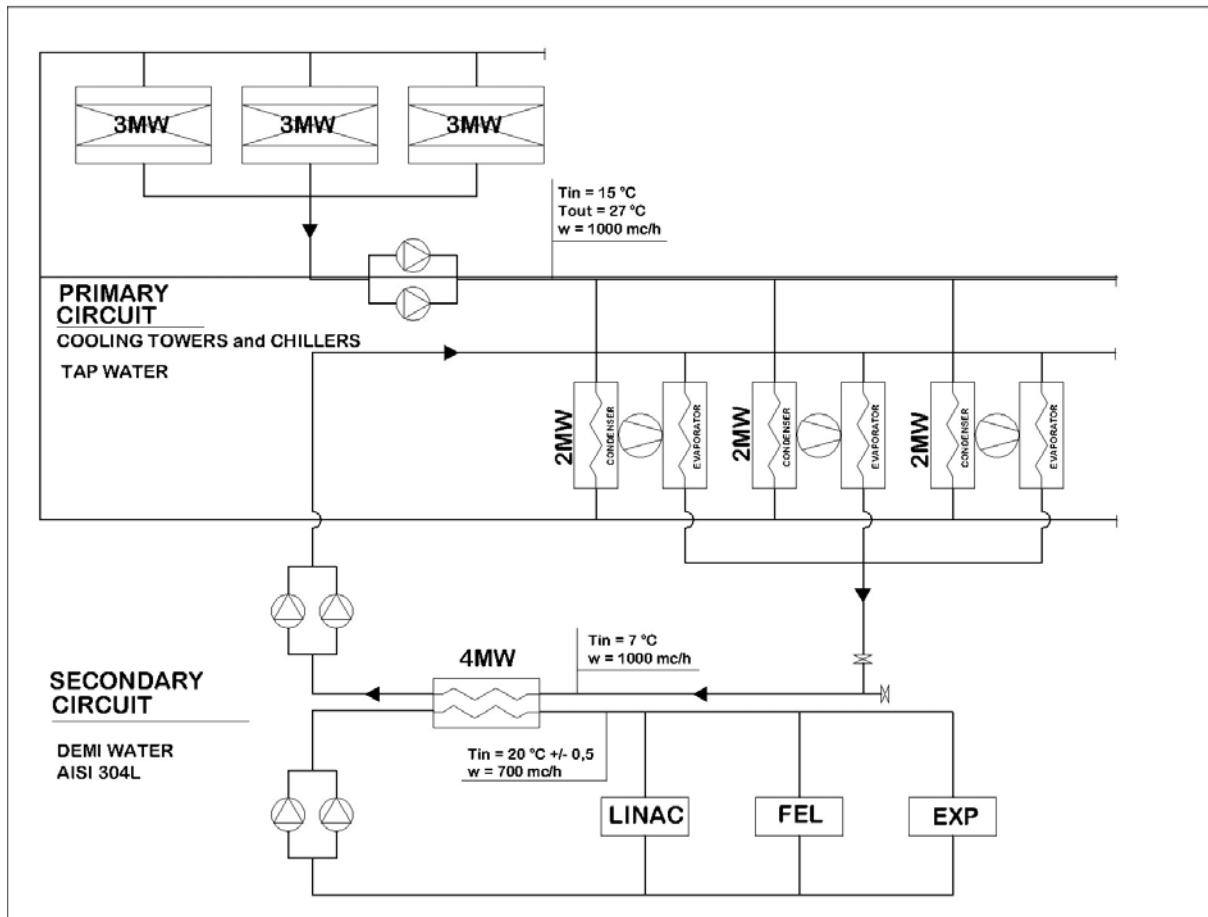

Figure 14.3.2: Schematic of the systems cooling circuit.

Table 14.3.2: System Parameters for the cooling circuits.

Circuit	t_{in} [°C]	t_{out} [°C]	Stab. [°C]	Q [m ³ /h]	P [bar]
Primary	15	27	+/- 2	1000	6
Secondary	20		+/- 5	1000	10-20
Tertiary	Tertiary circuits will be fully specified during the technical design stage of conventional systems.				

FERMI equipment will be cooled by a system having primary, secondary and optionally tertiary circuits. The primary circuit will use domestic water and will have cooling towers and chillers. The main-secondary circuit will use demineralised water that may be connected to several tertiary circuits (used when more stringent temperature stability is requested).

14.3.2.1 Primary Cooling System

The primary cooling system (shown in Figure 14.3.2) will cool the demineralised water of the secondary circuit via refrigerated water and heat exchangers. The refrigerators will use cooling tower condensers that may be by-passed during winter months. After passing through the cooling towers, the water is sent either directly to the heat exchanger or the secondary circuit. Water will be treated to avoid contamination by bacteria.

Redundancy will be built into primary components to guarantee continuity of operation. Equipment and piping will be built using carbon steel.

14.3.2.2 Secondary Cooling Circuit

Only one main secondary cooling circuit using demineralised water will be installed for all the FERMI facilities (i.e. linac, undulators and experimental beamlines and end stations). The technical specification of the circuit is given in Table 14.3.2.

The secondary circuit essentially consists of one pumping group, one heat exchanger, one closed expansion vessel, piping, regulation valves and control instruments.

The water temperature will be regulated using a mixing valve mounted on the primary circuit at the exit of the heat exchanger actuated via a feedback system that monitors and controls the cooling process (usually based on the inlet temperature of the circuit).

A ion-resin exchange unit will produce demineralised water ($1 \mu\text{S}/\text{cm}$) from the city mains supply and will also treat the circulating water in order to keep the electrical conductivity within the required design limits.

Redundancy has been built into the principal machinery to guarantee continuity of operation. Equipment and piping will be built in AISI 304 L stainless steel.

14.3.2.3 Tertiary Cooling Circuits (for the Linac Building, Undulator Hall and Experimental Hall)

Whenever operational specifications are beyond those provided by the secondary cooling circuit local tertiary circuits will be used. Several such systems are foreseen for special components of the linac, FELs and beamlines, See Figure 14.3.3.

The tertiary cooling circuit will be a skid-mounted cooling plant designed to assure the temperature of strictly regulated systems (to better than $\pm 0.1^\circ\text{C}$). Each plant essentially consists in one pumping group, one heat exchanger, one close expansion vessel, piping, regulation valves and instruments.

Redundancy has been built into the principal machinery to guarantee continuity of operation. Equipment and piping will be built in AISI 304 L stainless steel.

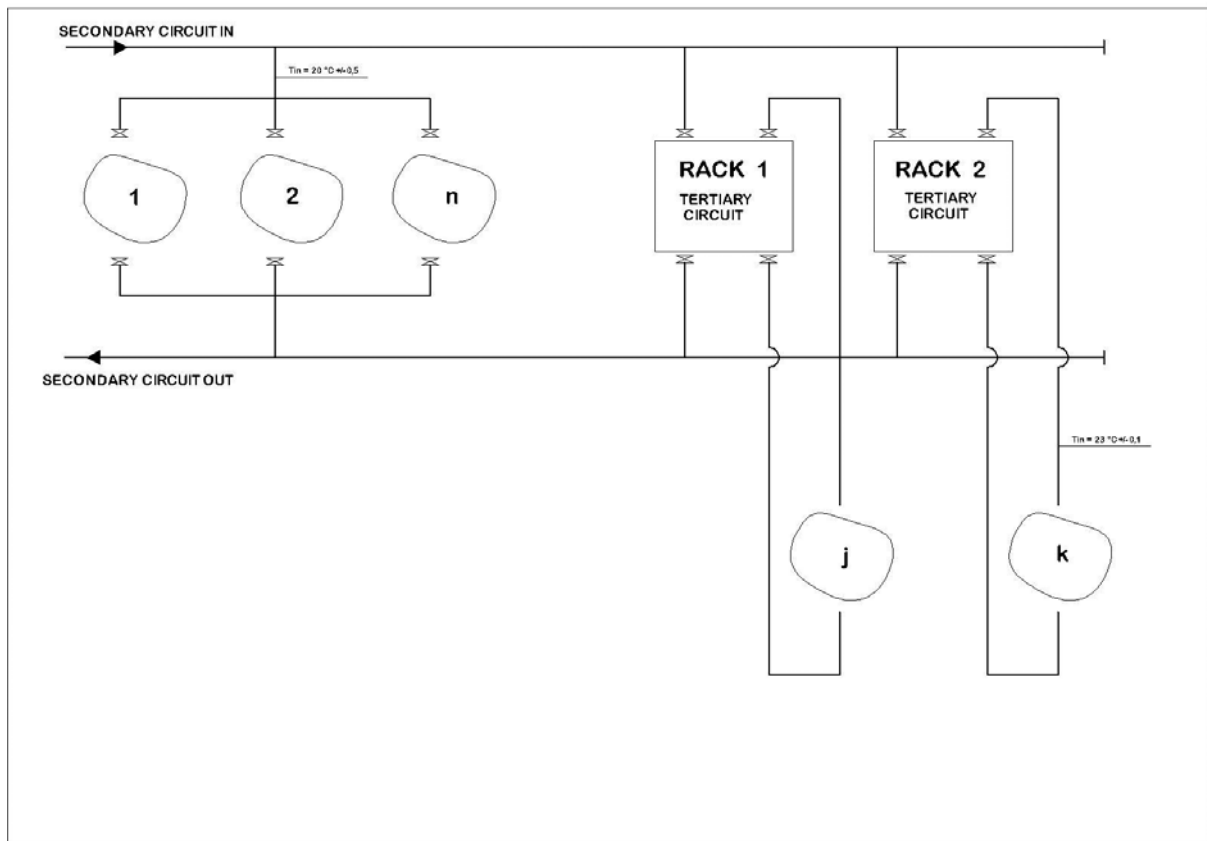

Figure 14.3.3:
Schematic of the tertiary cooling system.

14.3.3 Air Conditioning Systems

All FERMI buildings will be air conditioned. The HVAC system is particularly important for the linac, FEL and experimental halls, including service galleries and specific areas housing electronic equipment. Office and laboratory buildings will be conditioned according to regulations. The HVAC plants are placed in a central position with respect to FERMI infra-structures to minimize the length and quantity of ducts and conduits and the consequent thermal losses.

Each building will be served by a dedicated refrigerant cooling system (chillers, pumps, etc.) and a thermal station (methane boiler, pumps, etc.).

Redundancy has been built into the principal systems to guarantee continuity of operation. Parameters for the HVAC system are given in Table 14.3.4.

Table 14.3.4: Air Conditioning System Design Parameters.

<i>Building</i>	<i>t [°C] Winter</i>	<i>t [°C] Summer</i>	<i>Humidity</i>
Linac tunnel	27°C +/-1°C	27°C +/-1°C	50% +/-10%
Klystron Gallery	20°C +/-1.5°C	23°C +/-1.5°C	50% +/-10%
FEL Hall	22°C +/-0.5°C	22°C +/-0.5°C	50% +/-10%
FEL Service Gallery	20°C +/-2°C	25°C +/-2°C	50% +/-10%
Experimental Hall	20°C +/-0.5°C	25°C +/-0.5°C	50% +/-10%
Laser Rooms	20°C +/-0.5°C	25°C +/-0.5°C	50% +/-10%
Laboratories	20°C +/-2°C	25°C +/-2°C	50% +/-10%
Offices	20°C +/-2°C	25°C +/-2°C	50% +/-10%
Meeting Rooms (*)	20°C +/-2°C	25°C +/-2°C	50% +/-10%
Conference Room (*)	20°C +/-2°C	25°C +/-2°C	50% +/-10%

(*) For these locations the system will maintain specification only if the the number of people in the room does not exceed the design one.

14.3.3.1 Linac Building

For the extension of the existing buildings an upgrade of the existing HVAC plants is foreseen using new air treatment units in closed air circuits. Existing conduits will be used for the extension.

14.3.3.2 Undulator Hall

The FEL hall housing the beam transport system and undulators requires stringent air conditioning. The average ambient temperature must be stable to within +/- 0.7 °C over time intervals of a few hours to minimize mis-alignments, mechanical deformations and changes in the magnetic properties. Specifications will be better defined during the detailed technical design of the systems.

14.3.3.3 Experimental Hall

The experimental hall will house advanced electronics and optics that will need a thermally stabilized environment for proper performance. Ambient conditions will be subject to perturbations resulting from normal activities around the beamlines and experimental end stations (normal operation, installations and vacuum bakeouts). The environment will be thermally stabilized to +/- 1°C and critical areas, for example laser installations to +/- 0.5°C. Air temperature and humidity in the Experimental hall will be kept under strict control by closed circuit air units. Fresh air will be assured via a primary air unit.

14.3.3.4 Offices and Laboratories

As a general rule, fan coils will be installed in offices and laboratories and, when required, fresh air will be assured using a primary air unit. Special requirements for laboratories, the FEL control room and computer server locations will be met using dedicated systems.

14.3.4 Conventional Fluids and Gas Systems

Laboratories will be provided with compressed air, gaseous and liquid nitrogen and when required other gases or cryogenic liquids.

14.3.4.1 Compressed Air

A new centralized plant will supply compressed air to both technological and scientific areas. It will provide compressed air with a pressure of 7.5 bar. The plant is composed of three rotary compressors, dryers, oil removal filters and peripheral storage tanks. The tanks will guarantee pressure stability and reserve capacity against failure.

14.3.4.2 Nitrogen

Nitrogen will be stored in liquid form in a single tank centrally located. Three liquid nitrogen delivery taps will be installed: in the linac, FEL and experimental halls. A gaseous nitrogen line from the evaporation equipment of the tank will also be provided.

14.3.4.3 Water Plant Supports & Building Foundations

FEL systems and components are particularly sensitive to cultural noise and vibrations. This is especially true of low frequency ground vibrations caused by equipment such as rotary pumps and piping. The location and type of foundation for mechanical systems such equipment will be carefully evaluated and designed to minimise unwanted disturbance.

14.3.5 Control System for Auxiliary Plants

All the auxiliary plants will be locally controlled by PLCs that perform the control, regulation, signal acquisition and alarm functions. The PLCs will be connected via a data network to a supervising system composed of two servers, working in hot backup mode, and of a series of slave machines necessary for local plant management. The overall system will be similar to the existing one for reasons of operational compatibility and ease of maintenance.

14.3.6 Safety Systems

14.3.6.1 Fire-Protection System

The fire-protection system, designed in accordance with national fire-protection laws and regulations, includes a fixed water plant, a passive protection sub-system, a fixed inert gas extinguishing plant, distributed fire extinguishers, the fire detection system and the smoke extraction system.

14.3.6.2 Fixed Water Plant

This will be an up-grade of the existing plant. The system consists of a closed ring piping system connected to water hydrants and distribution panels. The FERMI plant will be an extension of the ELETTRA one.

14.3.6.3 Passive Protection Subsystem

All buildings will be passively protected by delimiting specific high-risk areas within each building.

The subsystem is designed to limit the propagation of a fire, in the event of a fire developing in spite of the application of active protection measures (detecting/extinguishing). Each area consists of one or more rooms that are identified and marked by physical fire-break boundaries, e.g.: fire proof doors (of the REI 120 type), etc.

14.3.6.4 Fixed Inert Gas Extinguishing Plant

The fixed inert-gas extinguishing plant (CO_2 , N_2 , etc.) consists in several cylinders located near high risk areas, specifically close to server and computer control centres. It will be activated by smoke detection units.

14.3.6.5 Fire-Extinguishers

Fire extinguishers will be portable or trolley types, loaded with CO_2 gas or powder. They will be installed in all buildings, in high-risk areas, in stairways, corridors and near access points to high fire-risk rooms.

14.3.6.6 Fire Detection System

The fire detection, warning and control system will consist of a series of local building panel boards and of main panel boards installed in the FEL control room and in the main entrance control room.

A network of automatic fire detection sensors (single units or linear sets) and alarm actuators will be installed in the rooms of protected buildings. Signals for this system will be sent to both central and local control units and activate several optical and acoustic alarm panels installed in corridors and stairways. The system will also actuate the closure of fire doors.

14.3.6.7 Smoke Extraction System

Smoke produced in the linac tunnel and in the FEL and experimental halls will be removed by the extraction fans of the air-conditioning system. The system will automatically inhibit re-circulation of air.

Smoke gathering in the experimental hall will be removed by automatic and/or manual opening of a series of smoke-extractors positioned close to the ceiling.

14.3.6.8 Information System

All buildings will be equipped with a speaker system connected to the main security centre or control room that will provide information to personnel. The system will be an extension of the existing ELETTRA one.

14.3.6.9 Special Plants

Areas of specific high risk to personnel, such as inert gas plants, will have safety systems conforming to safety regulations.

14.4 Modifications to Existing Systems

14.4.1 Drainage

A network of drainage pipes will collect all wastewater and channel it to the main sewer system. A separate draining system will dispose of rainwater. Dangerous fluids from laboratories, workshops and technological rooms will be collected and disposed of according to applicable regulations.

14.4.2 Sewage

All waste water will be channeled to a lift station where pumps will proceed to discharge the waste through a pressure line to the municipal disposal system of Basovizza located 500 m from the station and 12 m higher.

14.4.3 Liquid Nitrogen Distribution

The Liquid Nitrogen tank now located next to the ELETTRA storage ring building will be moved to another location adjoining the Experimental hall. The relative piping for distributing the nitrogen gas will also be modified. The Liquid Nitrogen tanks close by the MM building will require modification in case of interference with the new road network.

14.4.4 TASC CNR-INFM Infrastructures (Building MM)

The conventional infrastructure of the TASC CNR-INFM building MM including normal water, both hot and refrigerated, compressed air, demineralised water, electrical power, telephone and data links and the fire alarm connection are all connected to central plants via an underground conduit. The conduit is directly affected by the new FERMI constructions, in particular by the FEL hall and associated service gallery. Modifications to the conduit, re-piping and re-cabling will be performed. In addition, local plants will be set up to provide hot and chilled water.

14.4.5 The ELETTRA Facility

The external lines supplying the ELETTRA facility with water, gas and electrical power will be modified to additionally supply the FERMI facility. As earlier mentioned, the liquid nitrogen tanks located in proximity to the FEL hall will be relocated to a central area. Sewage pipes will also be upgraded and relocated.

Table of Contents

14	Civil Engineering	359
14.1	Introduction	360
14.2	Buildings	362
14.2.1	Linac Building	363
14.2.2	Undulator Hall	365
14.2.3	Experimental Hall	366
14.2.4	Conventional Installations	368
14.3	Auxiliary Plants	370
14.3.1	Electrical Power System	370
14.3.2	Cooling Systems	373
14.3.3	Air Conditioning Systems	375
14.3.4	Conventional Fluids and Gas Systems	377
14.3.5	Control System for Auxiliary Plants	377
14.3.6	Safety Systems	377
14.4	Modifications to Existing Systems	379
14.4.1	Drainage	379
14.4.2	Sewage	379
14.4.3	Liquid Nitrogen Distribution	379
14.4.4	TASC CNR-INFM Infrastructures (Building MM)	379
14.4.5	The ELETTRA Facility	379