

# Recent Developments for Undulators at PETRA

Markus Tischer

– on behalf of the DESY Insertion Device Group FS-US –

PHANGS, 4-5 December 2017, Trieste

- > Magnet sorting for hybrid structures
  - Magnet sorting for PPM and hybrid structures
  - Sorting by M and single point NS data only
  - Magnet error model
  - Measurement of magnet errors by a Hall probe array
  - Results
  
- > Phase shifter integrated in an undulator hybrid structure
  - Motivation & Principle
  - Implementation
  - Magnetic response / Measurement results

Coworkers: Pavel Vagin, Andreas Schöps, Paul Neumann, Thorsten Vielitz, Daniel Hemmenga

# Helmholtz coils + single point North-South

- > Sorting by M and single point NS values only is not efficient for a hybrid structure
- > Magnet model with individual magnetization of each subblock according to Helmholtz and NS measurements, as single „focal“ point
- > Radia model of short undulator with non-ideal magnet in different orientations (pos/neg, top/bot) to get signatures for sorting

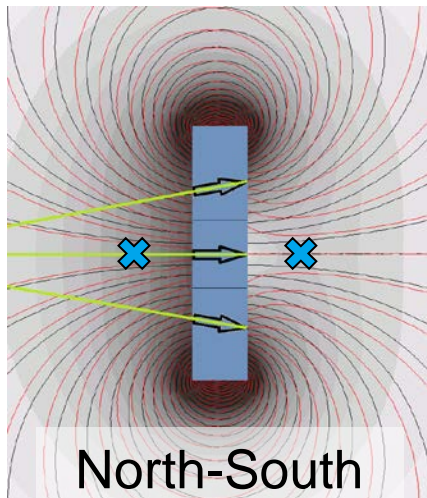
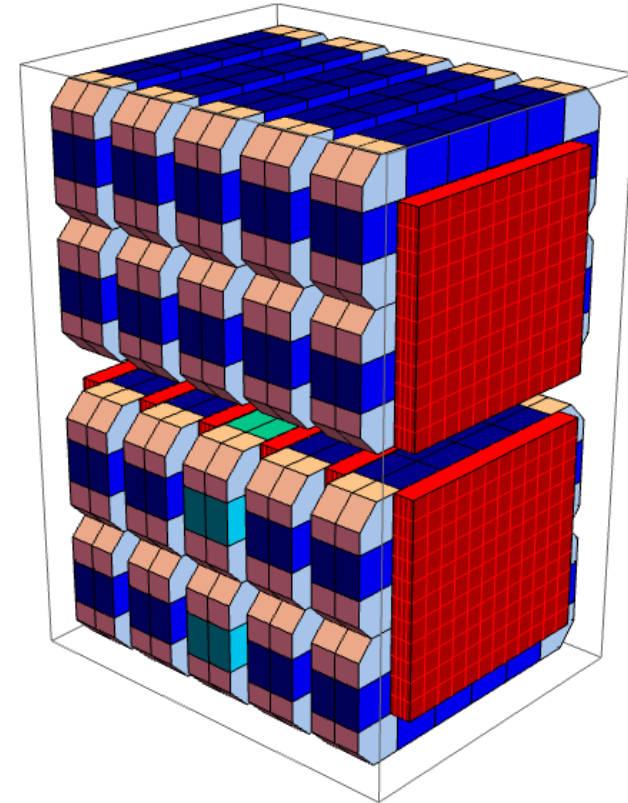

North-South  
measurement

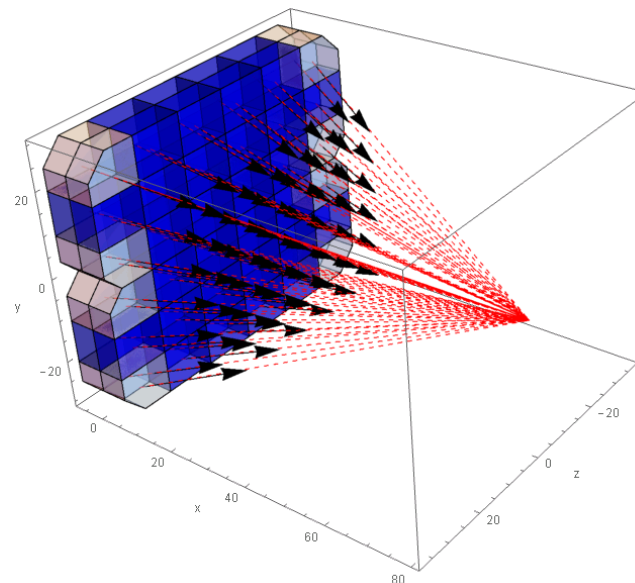

# On-axis field and field integral signatures of magnet errors

## On-axis field longitudinal dependence

## Field integral transverse dependence

Single magnet

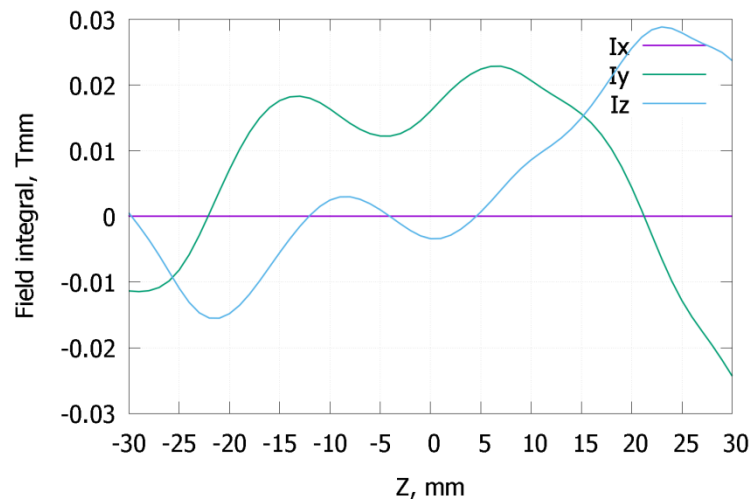
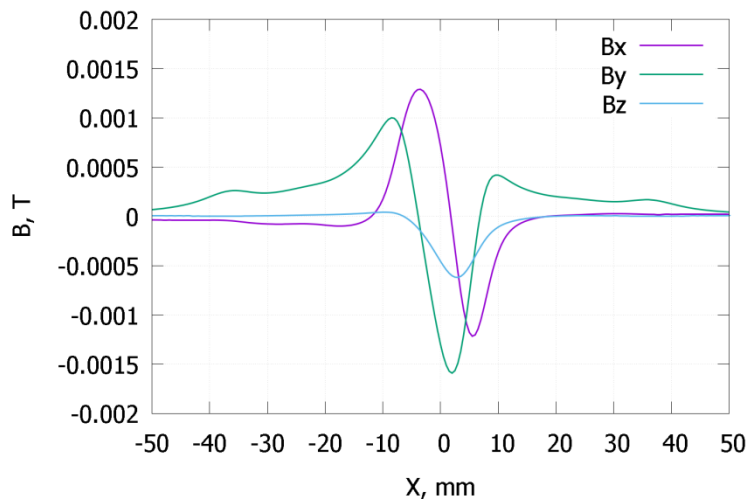

2m undulator, 250 magnets

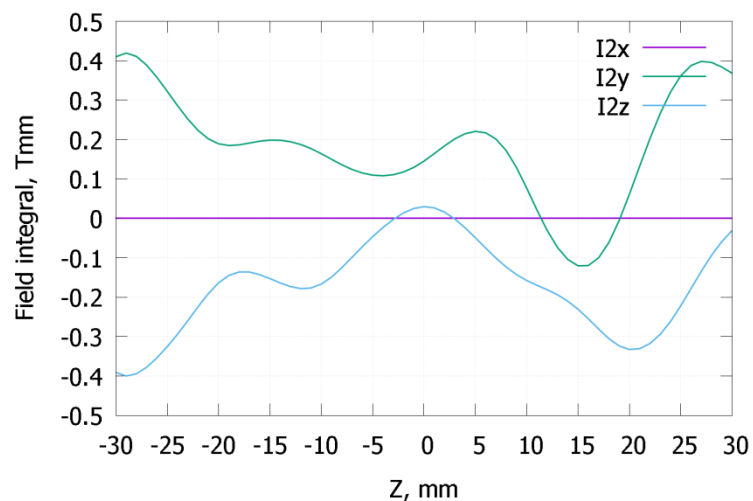
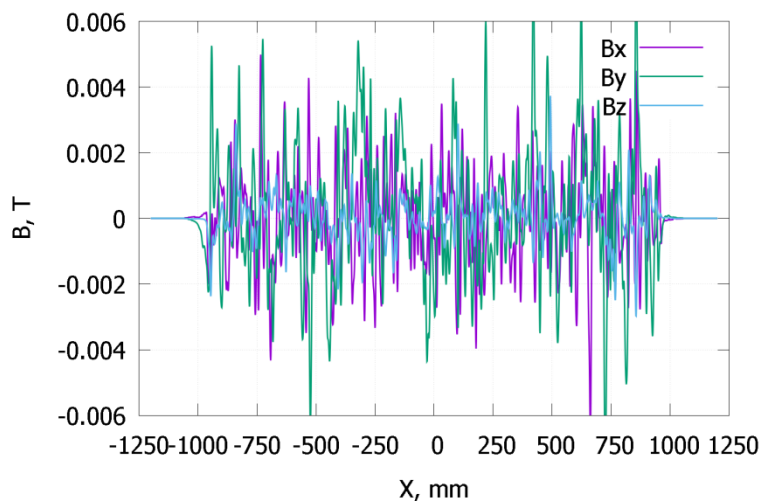

# Optimization of sorting by random swap of magnets

- > Take two random magnet positions
- > Swap them and calculate error
- > If new error is larger, then put magnets back
- > Repeat

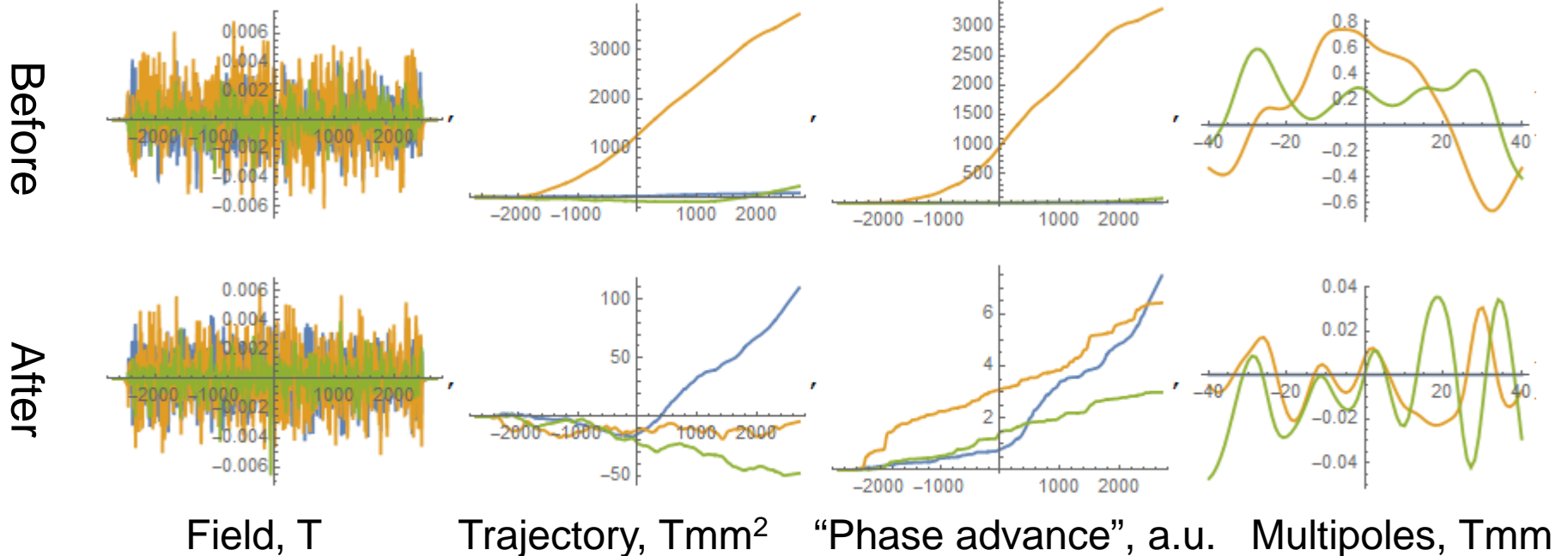

# TLV493D Hall sensor array

- > Infineon TLV394D integrated 3D hall probe
- > Built-in 12-bit ADC(100uT/LSB), temperature sensor, I2C interface
- > 3x3mm TSOP-6 footprint, 5mm sensor pitch on PCB
- > Linear (<1LSB) field measurement range up to +/-130mT
- > Angular positioning error and gain calibrated with NMR
- > Measurement of the whole fieldmap within few seconds

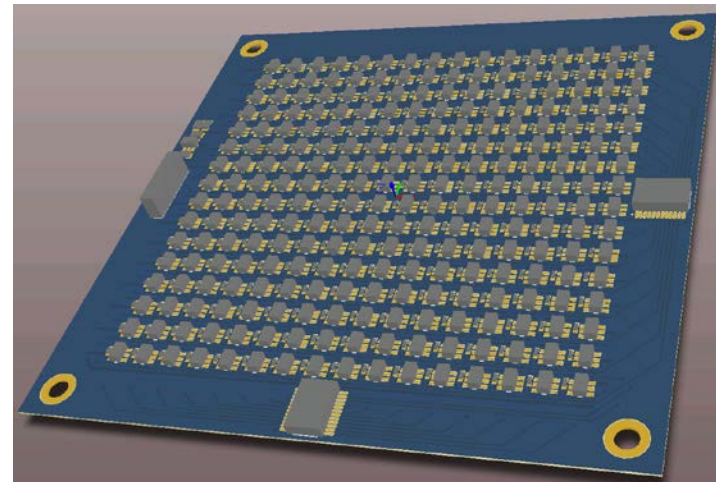
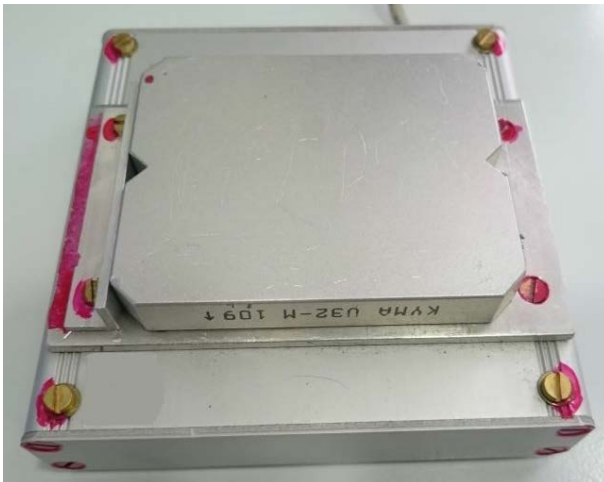
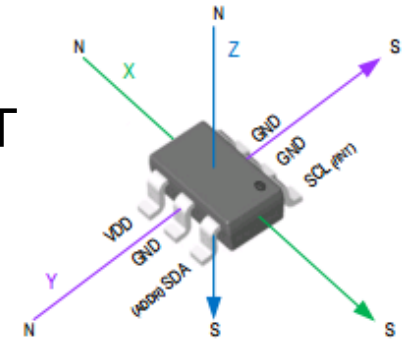



# Random optimization of magnet errors to match the measured field

## Measured fieldmaps

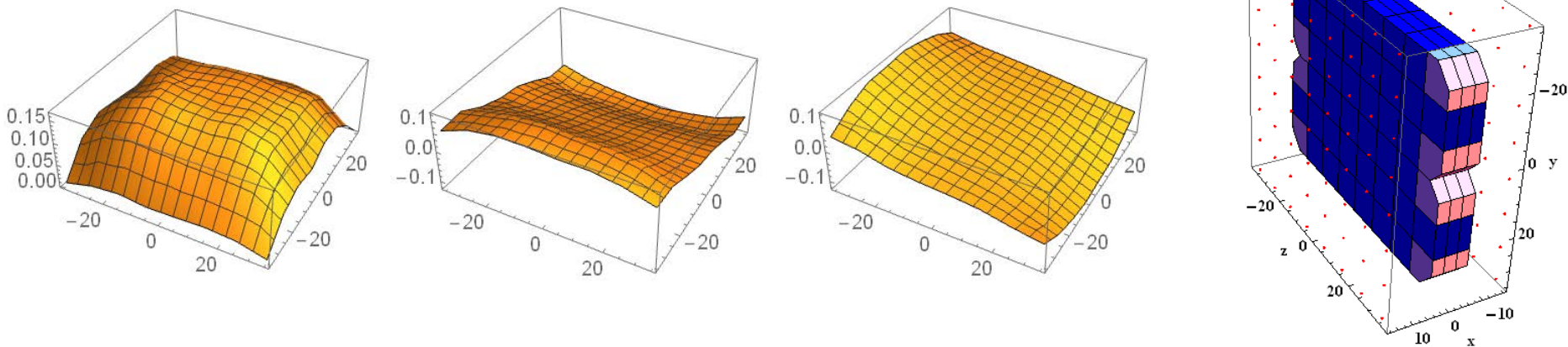

## Field difference of model and measurement before optimization (2mT scale)

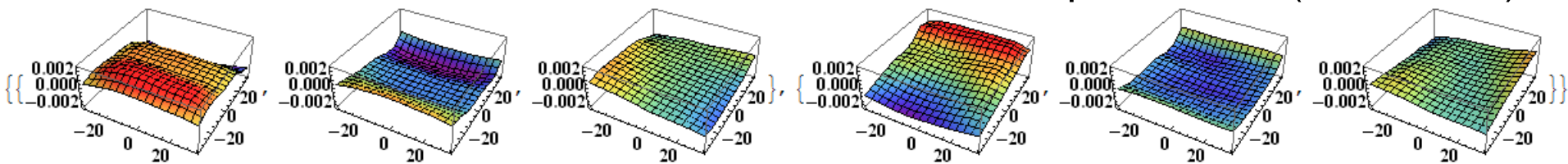

## Field difference of model and measurement after optimization (0.2mT scale)

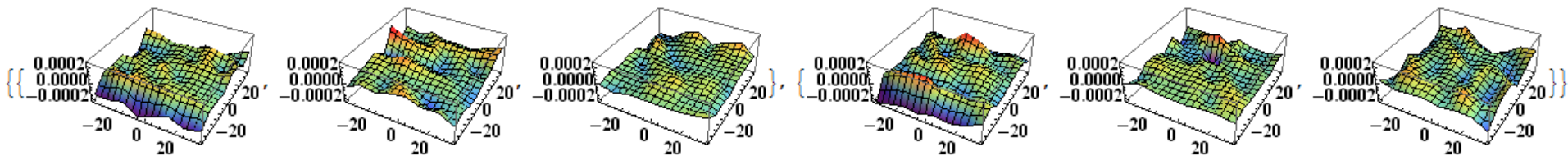

# Magnet model optimization results compared to Helmholtz measurements

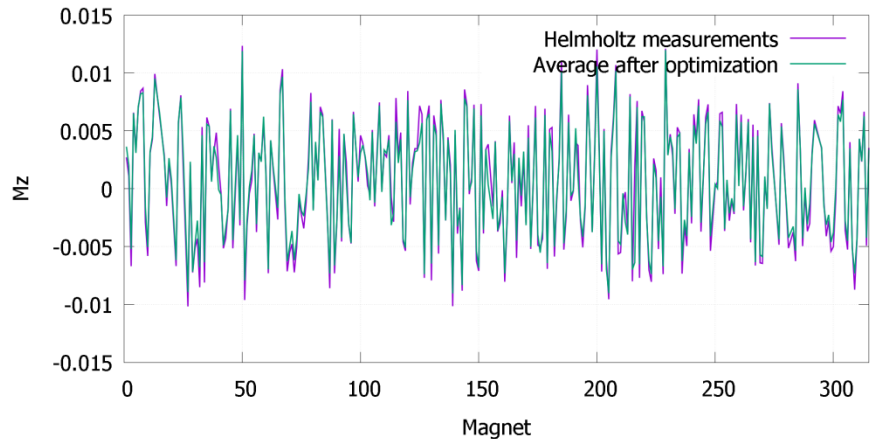
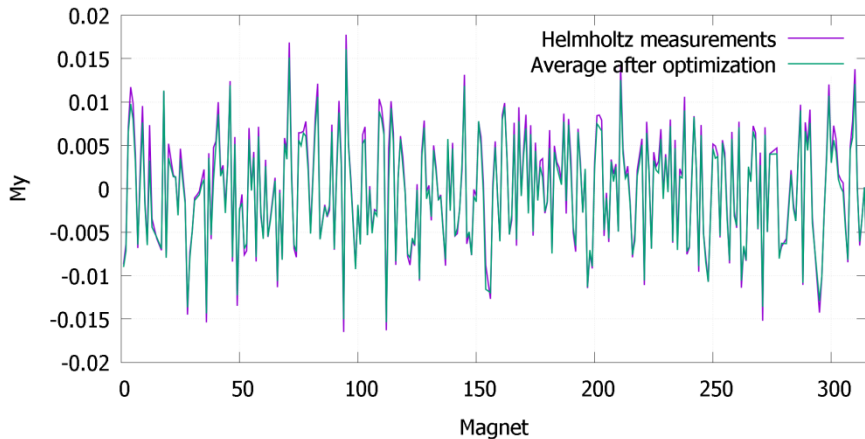
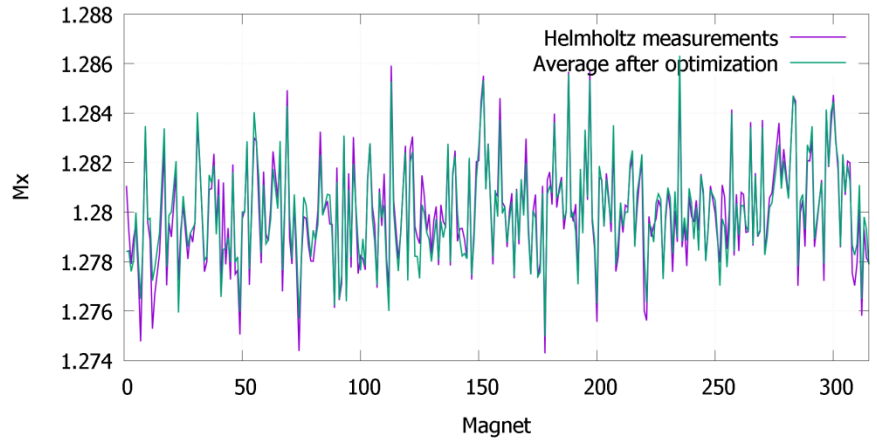
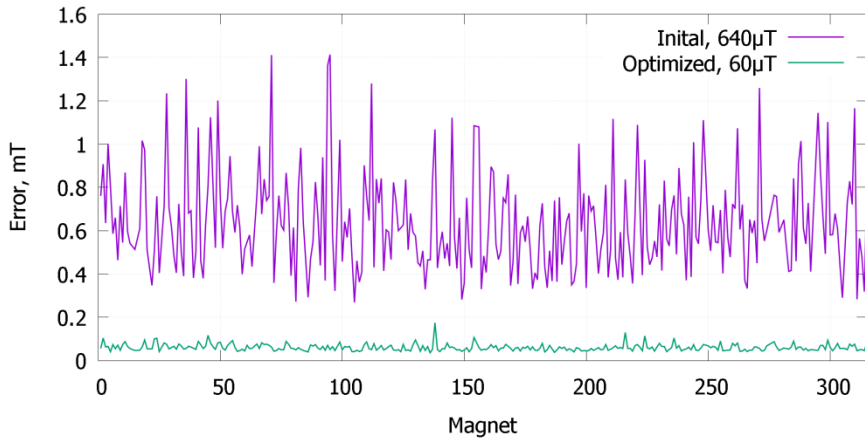



# Previous experience, without proper sorting

- > Gap dependent kicks
- > Multipoles gap dependence
- > Require additional gap dependent shimming

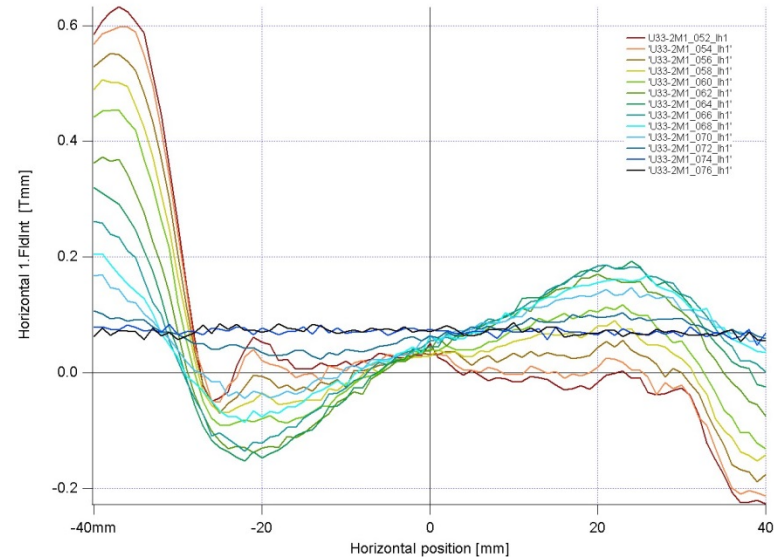
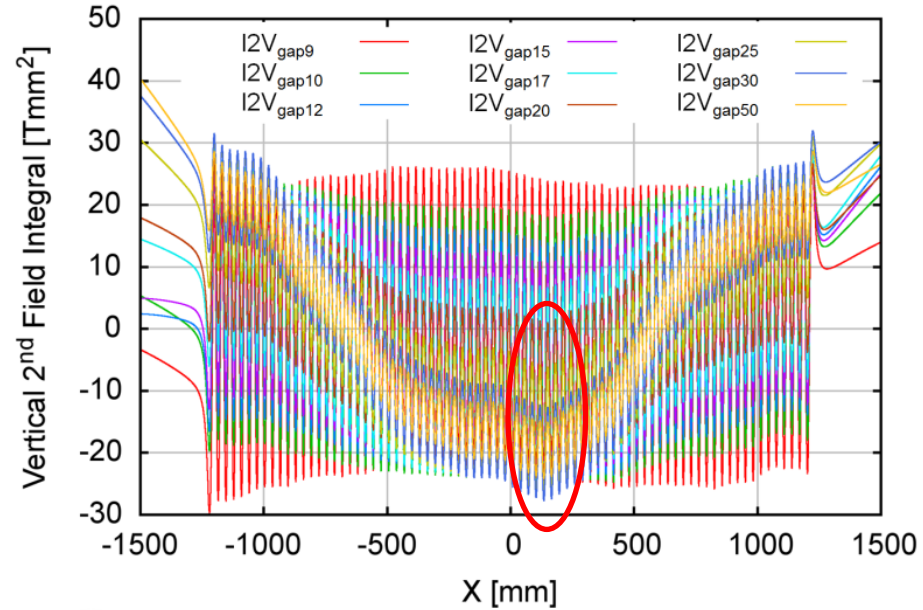
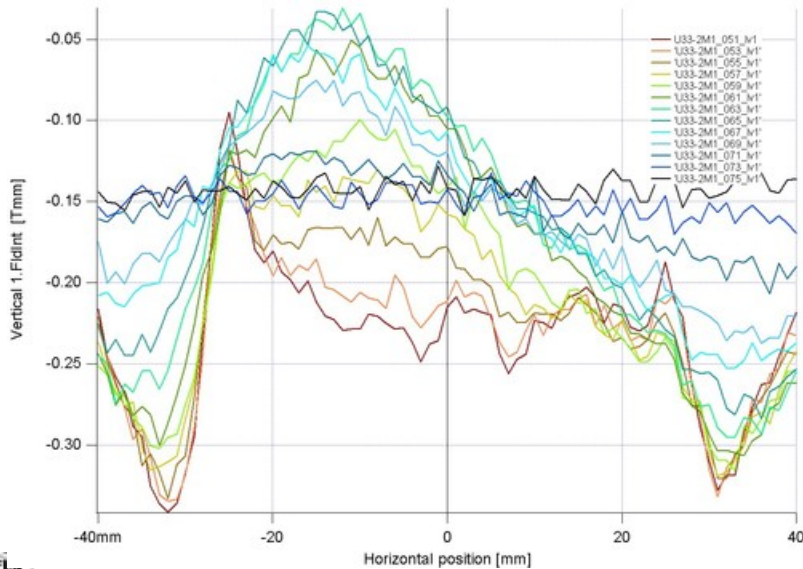

# Last devices with new sorting, gap dependence

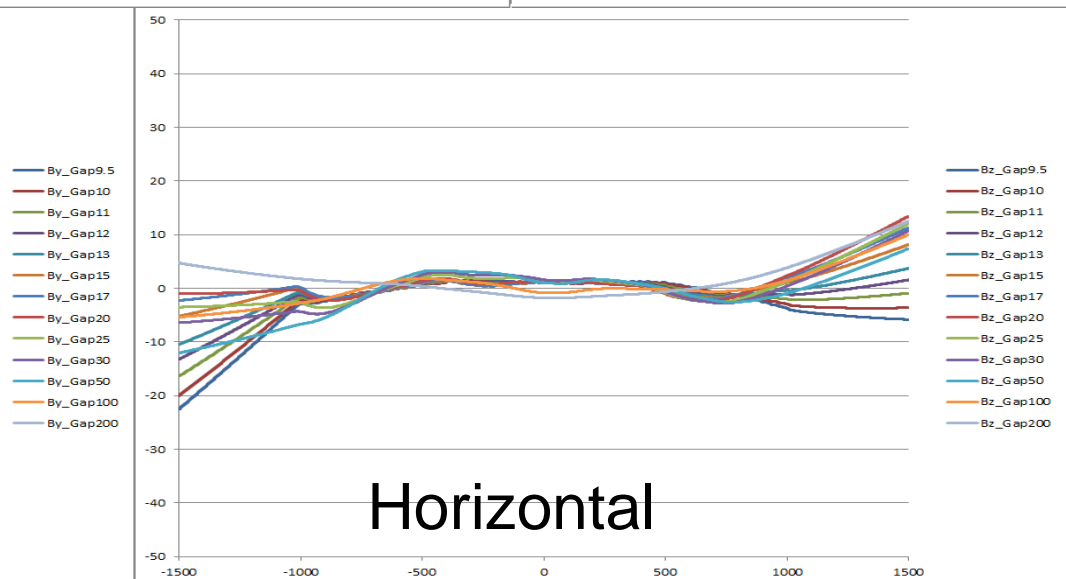
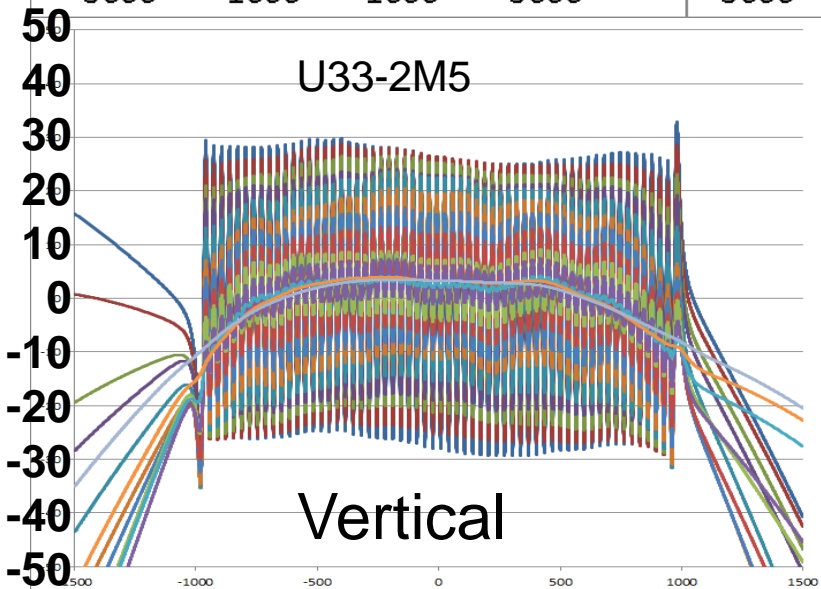
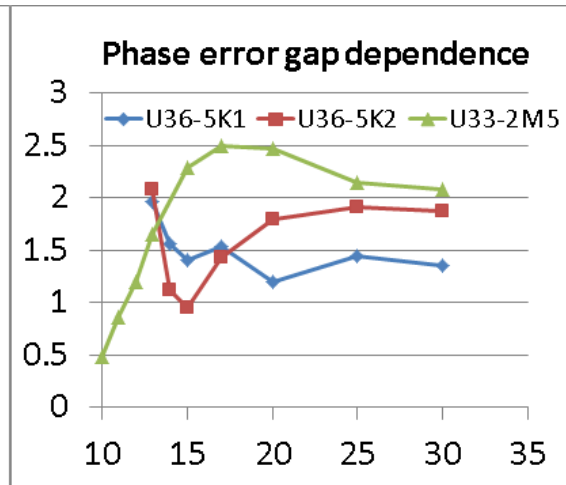
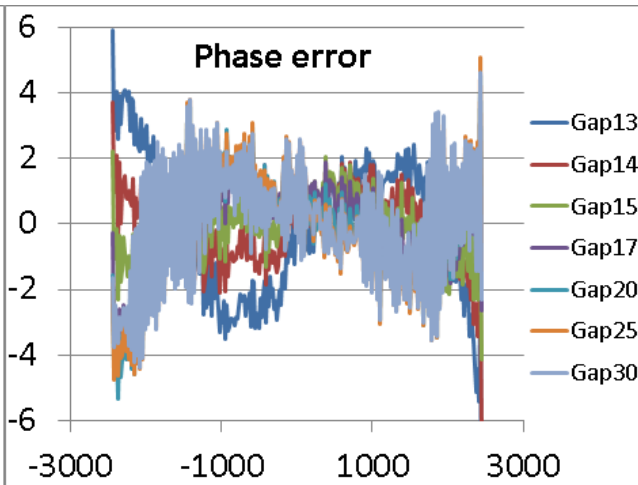
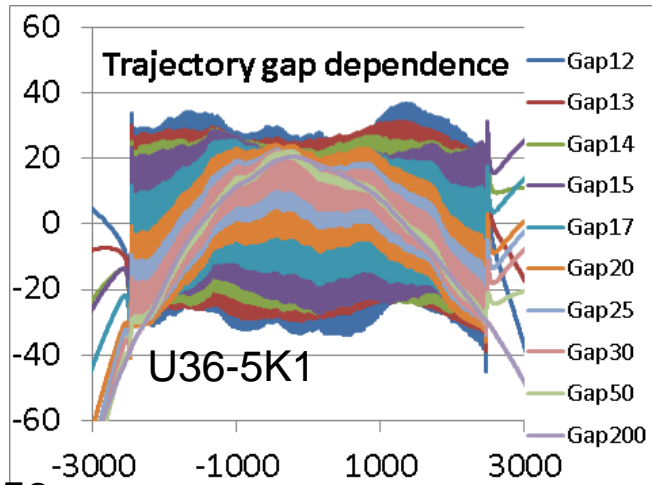

> NO gap dependent kicks inside the structure, phase error < 2 deg

> Negative curvature at open gaps - Earth field

# Last devices with new sorting, multipoles gap dependence



- > Magnet sorting for hybrid structures
  - Magnet sorting for PPM and hybrid structures
  - Sorting by M and single point NS data only
  - Magnet error model
  - Measurement of magnet errors by a Hall probe array
  - Results
  
- > Phase shifter integrated in an undulator hybrid structure
  - Motivation & Principle
  - Implementation
  - Magnetic response / Measurement results

# Suppression of Higher Undulator Harmonics

- > Problem: usual X-ray monochromators also transmit the higher undulator harmonics very efficiently → degradation of signal/background
- > Solutions: modify the undulator emission characteristics such that higher harm. are shifted to non-integer multiples

- “Quasi-periodic” undulator (S.Sasaki, 1995 ff.)

periodic:

same structure repeated over and over again

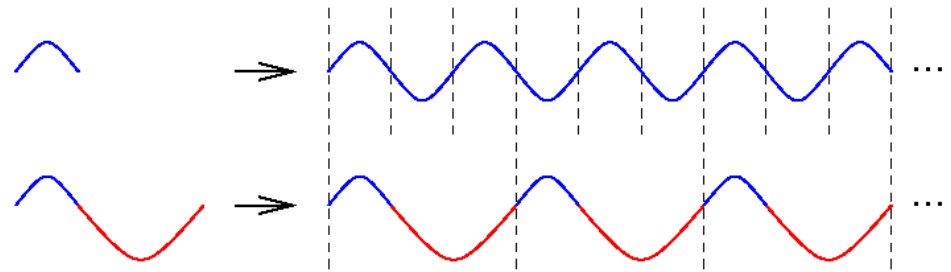

quasiperiodic:

finite number of elements repeated in irregular order, periodicity on small scales but no global periodicity

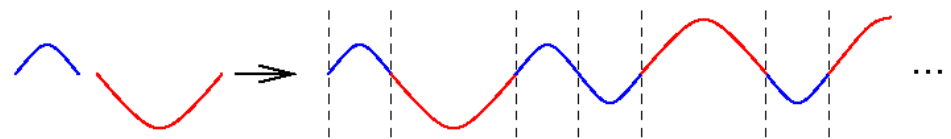

- Other means: mirrors (suppression  $>1e-6$ ), monochromator detuning (suppr.  $1e0...1e-2$ )  
energy dispersive detectors (suppr.  $1e-1...1e-2$ )

# Existing QPUs in the World

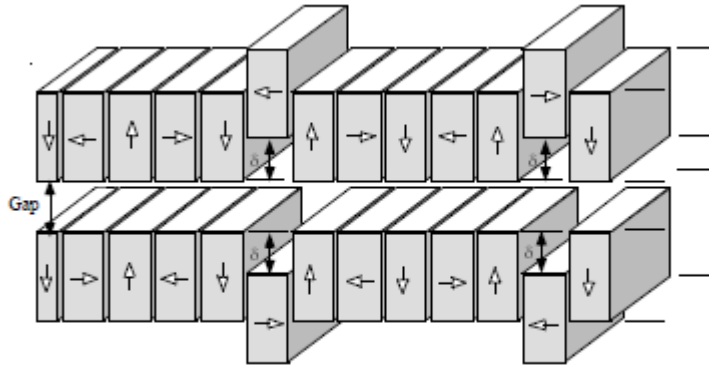

Figure 1: 3D view of the quasi-periodic undulator

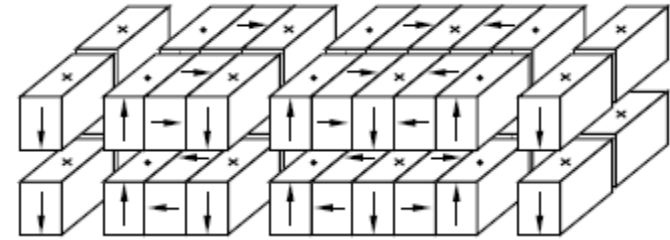

Figure 8: Schematic of the new variable polarization quasi-periodic undulator.

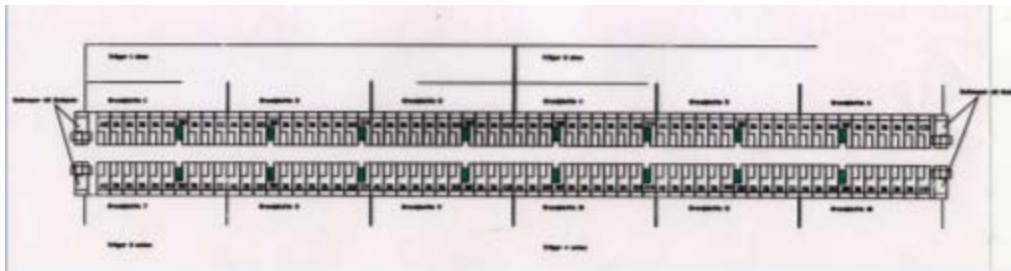

Figure 1: Side view of one UE212 section with the 4.55 m long single piece iron yoke/vertical pole structure and added horizontal poles. The inter coil connections for the two individual vertical power circuits are implemented on left or right side of each beam. The horizontal coils are attached all in series.



# Quasi-Periodic Undulators

- > Various QPU schemes have been implemented at several SR-facilities
  - realized in permanent magnet or electromagnetic technology
  - applied to planar and helical undulators
- > Usual concept
  - use the same mechanical design of the magnet structure as for the regular device
  - apply a (reversible) quasi-periodic modification of the magnet structure
  - alternative approach: also a periodical modification will cause a shift of the harmonics (J.Skupin, unpub.)
- > Properties
  - higher harmonic suppression in the order of  $\sim 0.1 \dots 0.02$
  - flux reduction of the desired harmonics by up to  $\sim 30\%$
  - suppression can usually only be optimized for one energy and pair of harmonics
- > General idea: generate well-defined phase error by variation of the magnetic field

→ single phase step

# Phase Shift Without Trajectory Offset



# 3rd/9th Harmonic Suppression when Operating at 1st

Phase step = -65

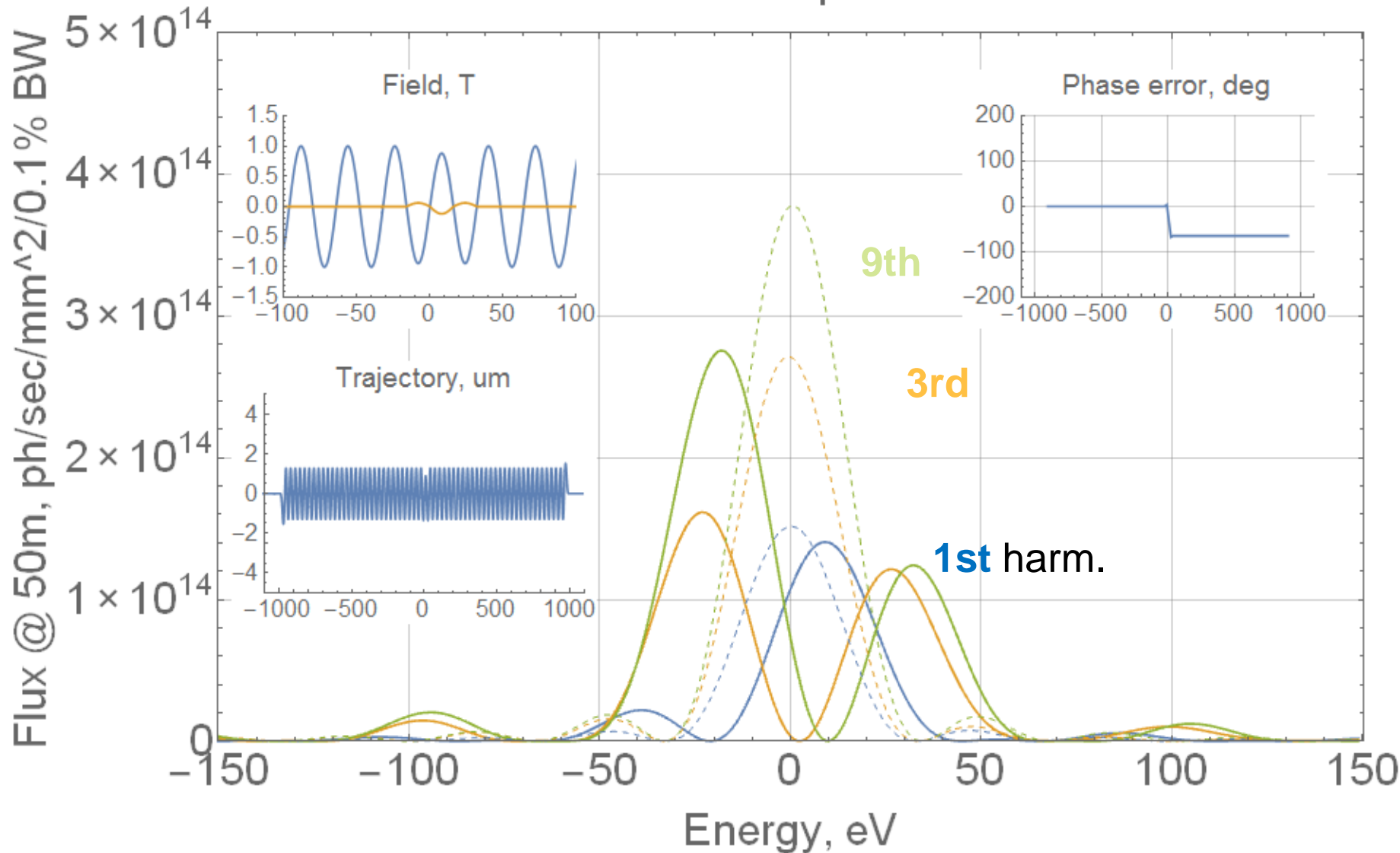

# 9th Harmonic Suppression when Operating at 3rd

Phase step = -89

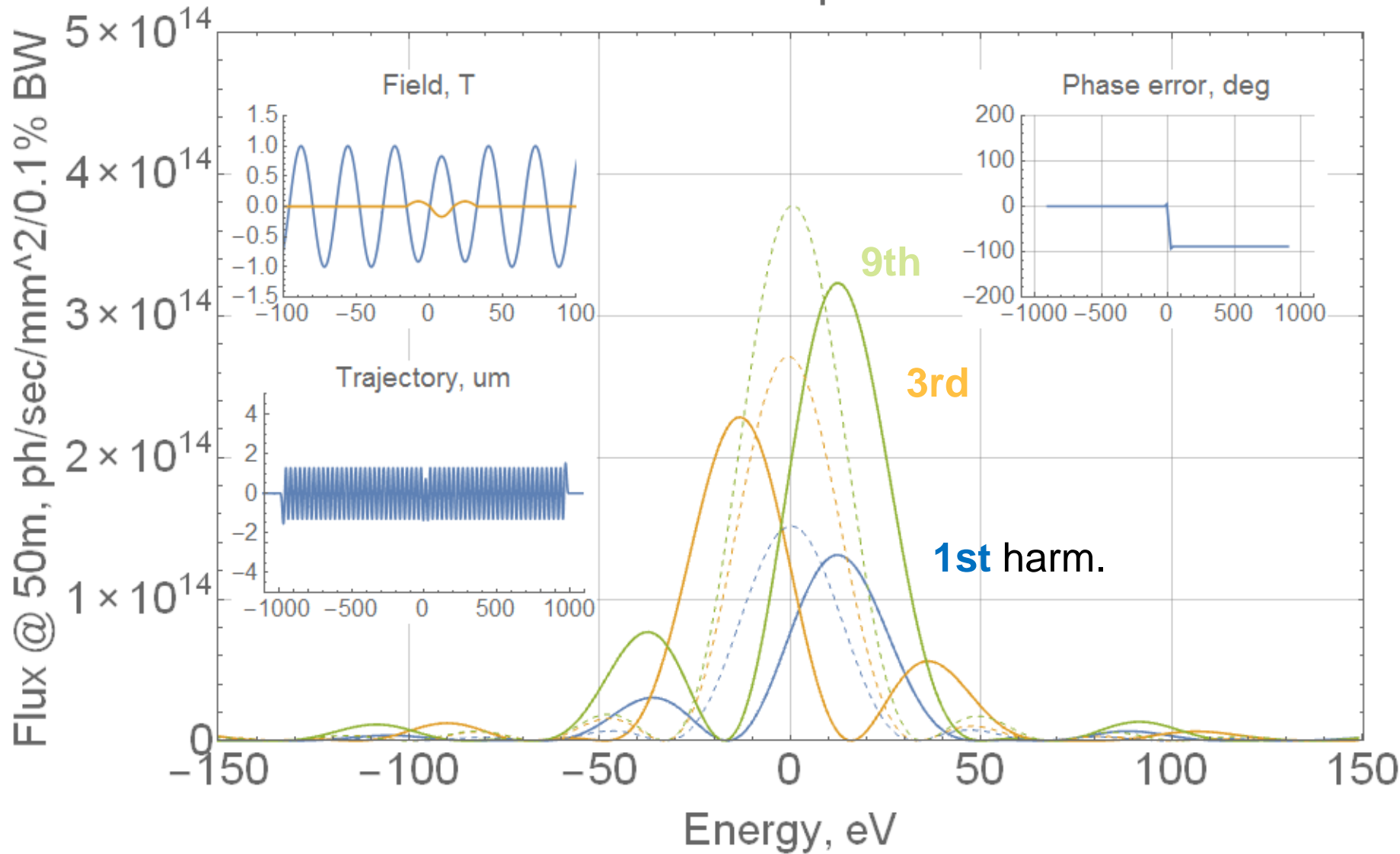

# Phase Shift by Trajectory Offset



# Spatial Distribution

Phase=-80deg, X=60m, E=18557eV, BW=30.4635+-0.132639eV

Phase=-80deg, X=60m, E=18557.5eV, BW=30.4643+-0.132997eV

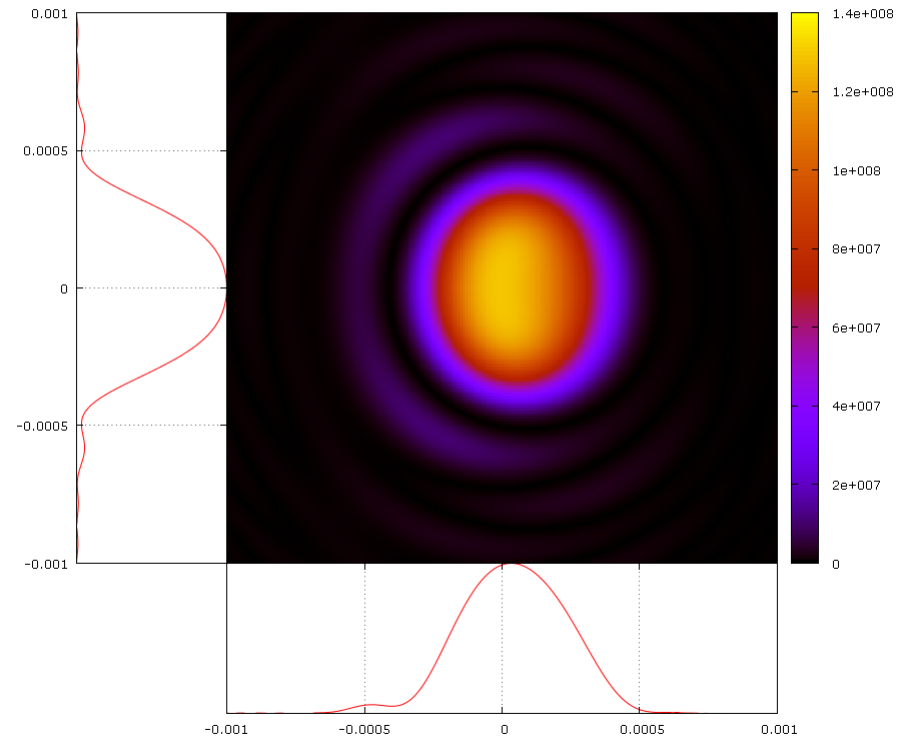
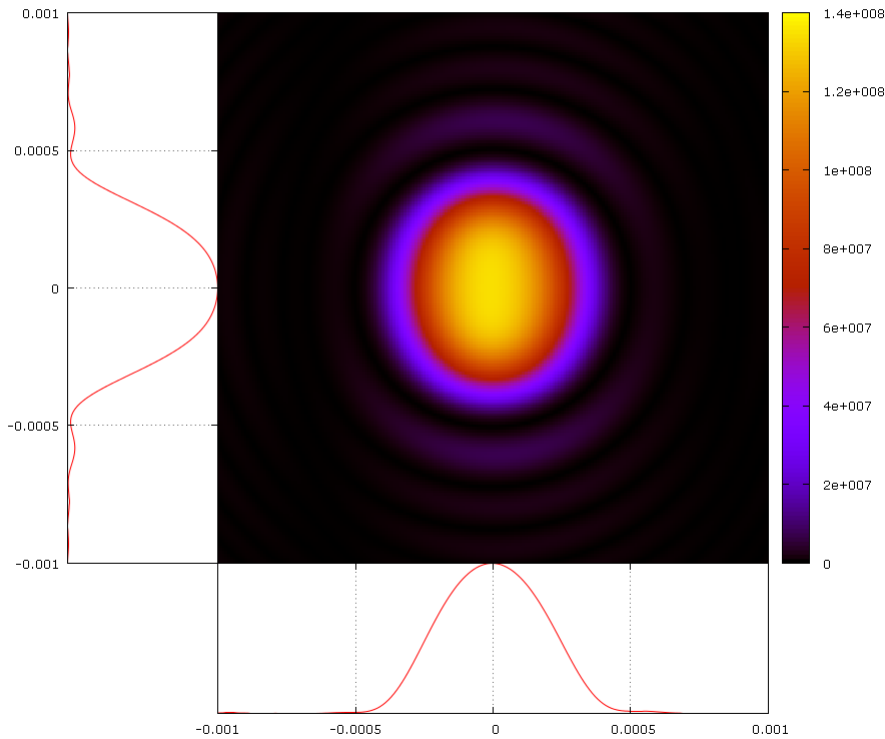

9<sup>th</sup> harmonic, 80 deg phase shift, with and without trajectory offset



# Local Phase Shifter Integrated in a Hybrid Structure

- > Goal: Adjust the suppression dynamically and for any gap – or switch it off
  - use an ordinary undulator structure
  - implement a single phase shifter in the center of the magnet structure

## > Various schemes were studied

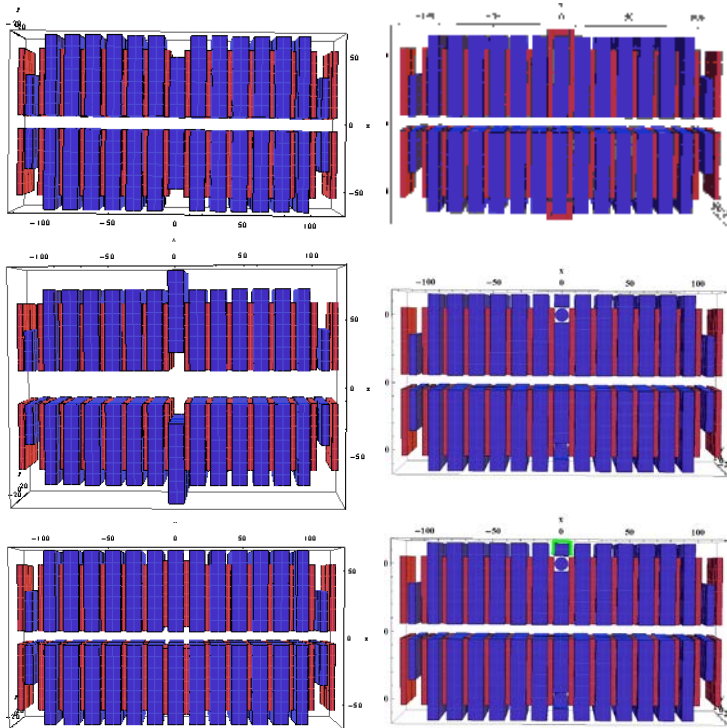

## > Final concept

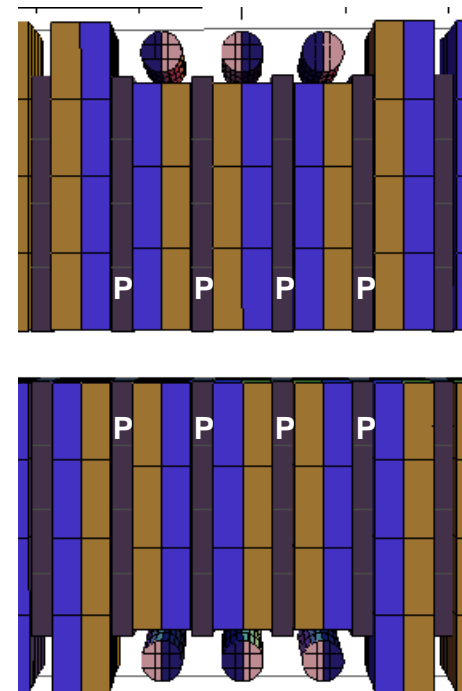

Rotating magnet

Shortened  
regular magnets

Retracted Poles

This principle is  
also applicable for  
Harmonic Lasing  
schemes at FELs!

# Mechanical Design of Local Phase Shifter

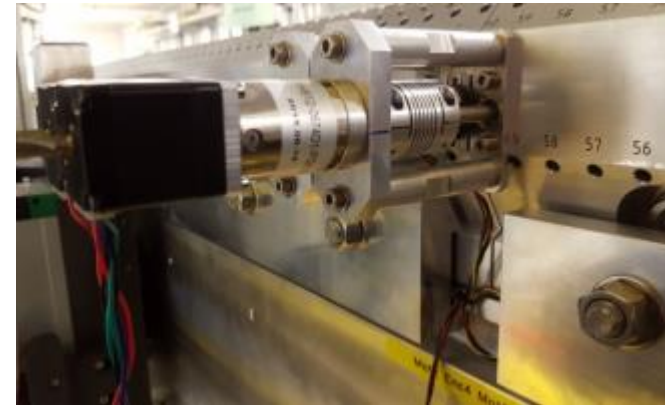
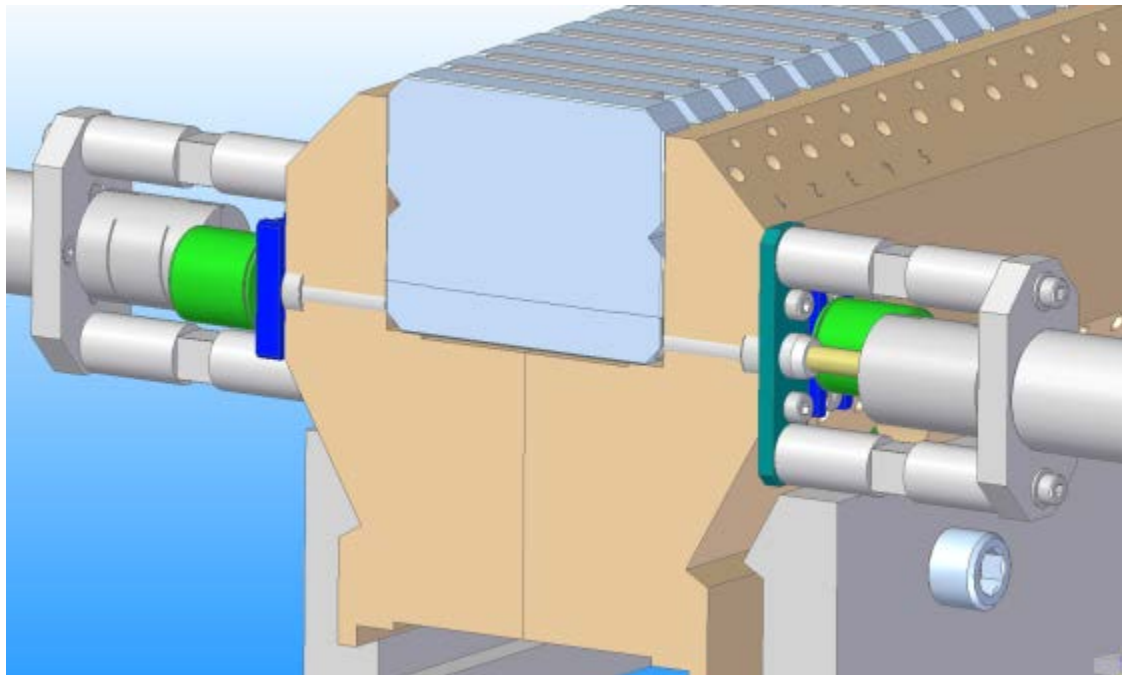
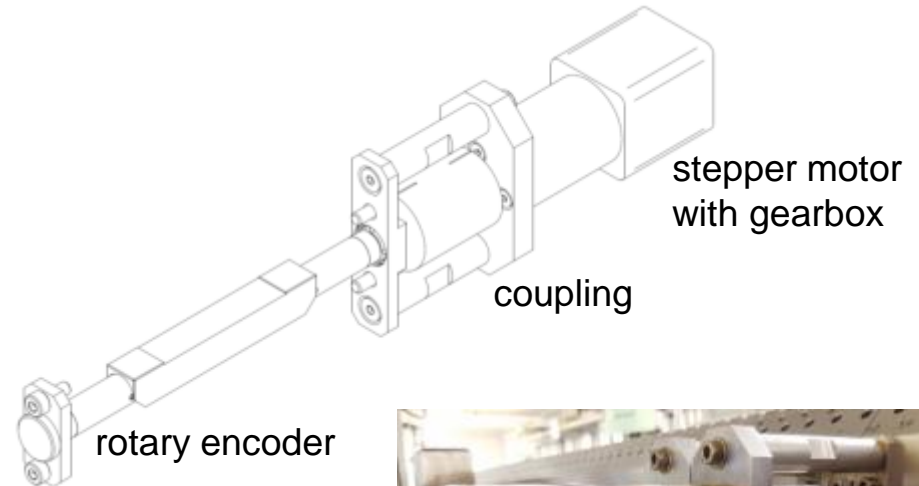
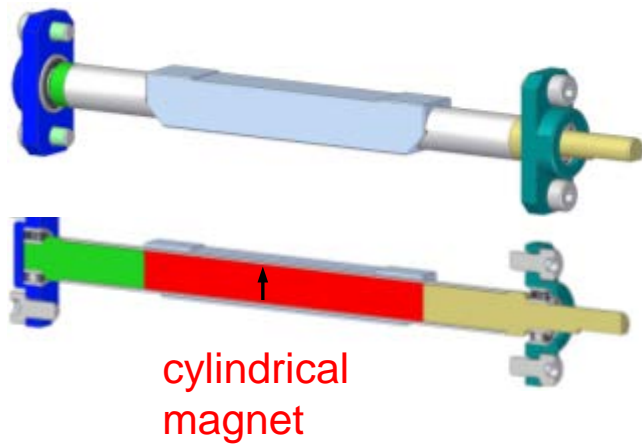

# Different Operation Modes

Reversing outer magnets for positive phase shift by trajectory offset

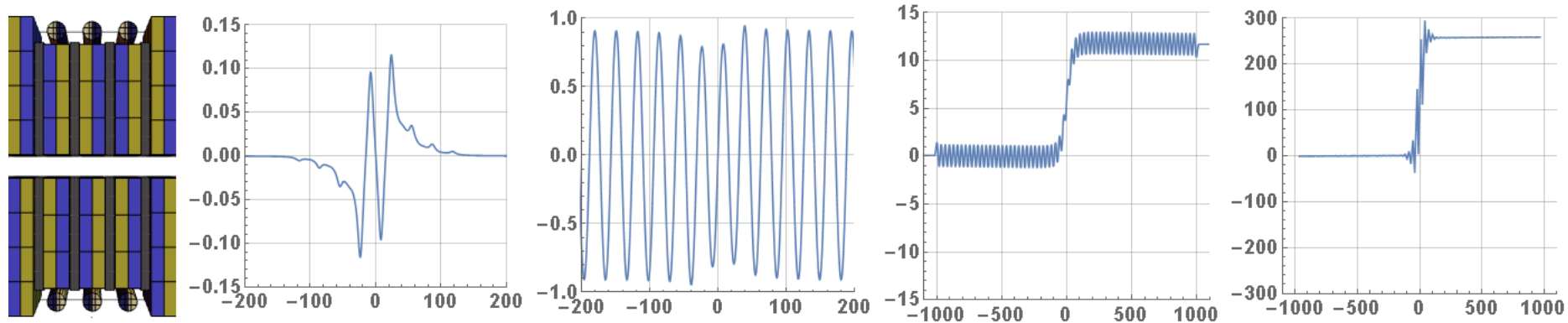

Reversing center magnets for zero trajectory offset and negative phase step

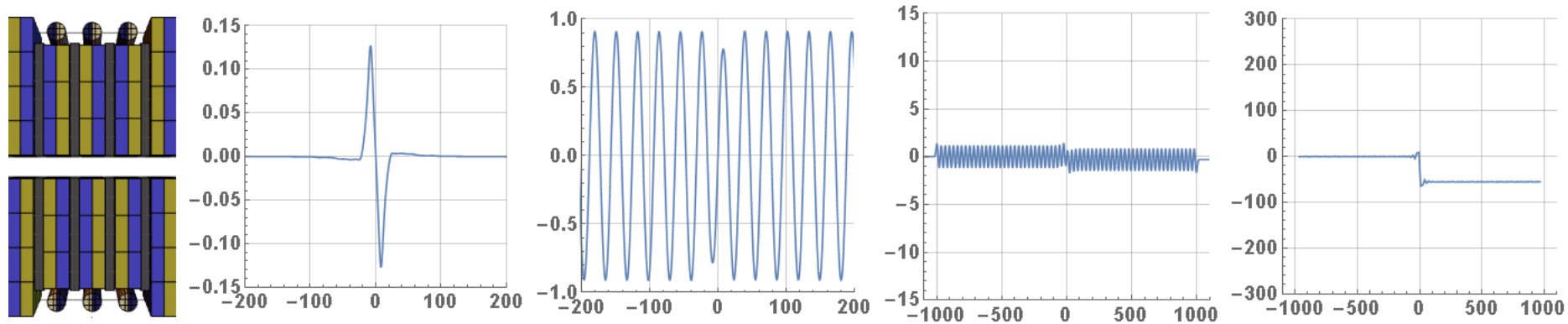

Field signature, T

Field, T

Trajectory,  $\mu\text{m}$

Phase, deg

# Different Operation Modes

Retract poles for maximum negative phase step (decreased with gap opening)

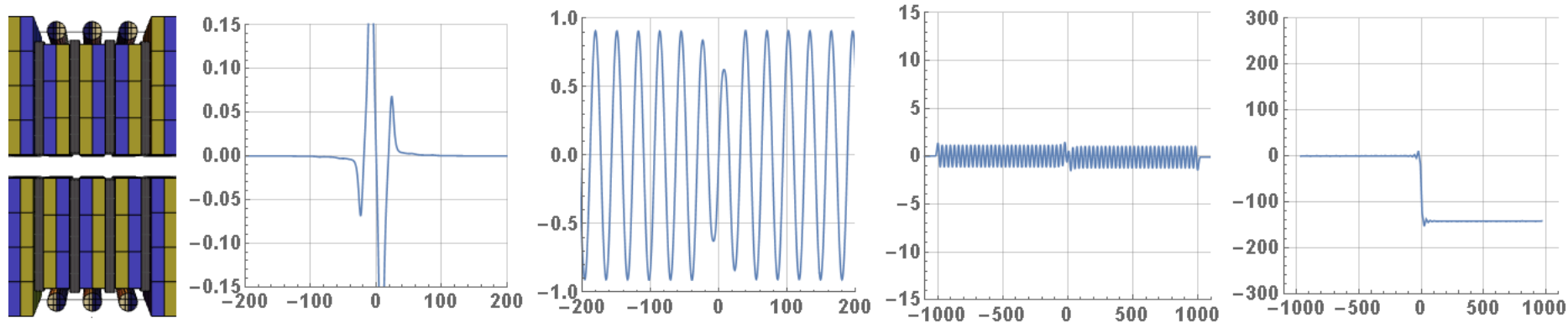

Positive phase step by trajectory offset is stronger even with retracted poles and allow for both positive and negative phase steps  $\pm 150^\circ$

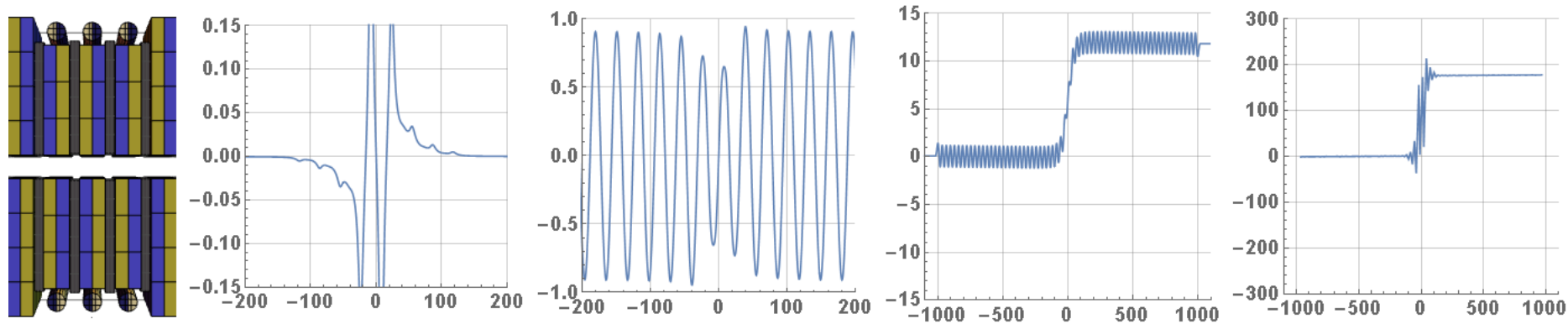

Field signature, T

Field, T

Trajectory, um

Phase, deg



# Magnetic Measurement Methods

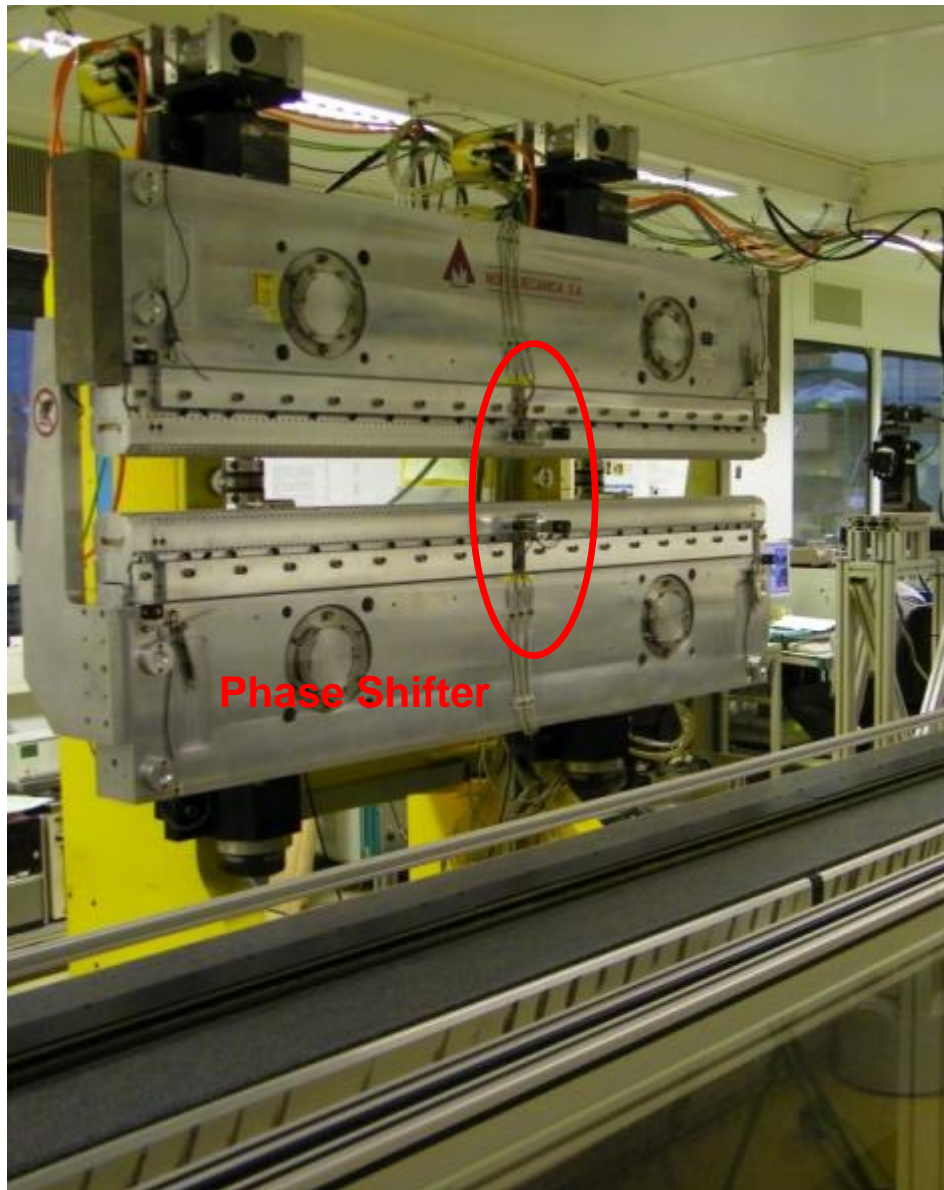

## > Hall probe bench

- 12m measurement bench
- 1D-Bell-probeHall probes
- pickup-coil
- 3D probes

## > Field integral probe

- Stretched wire
- Long Coil
- Moving/Rotating Coil

## > Calibration tools

- NMR for calibration of Hall probes
- Interferometer, Touch probe as a mechanical 3D-measurement probe

# Phase Adjustment by Outer 4 Motors

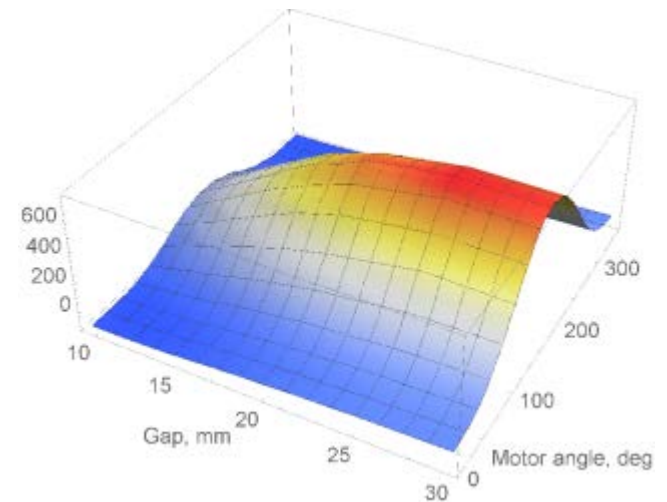
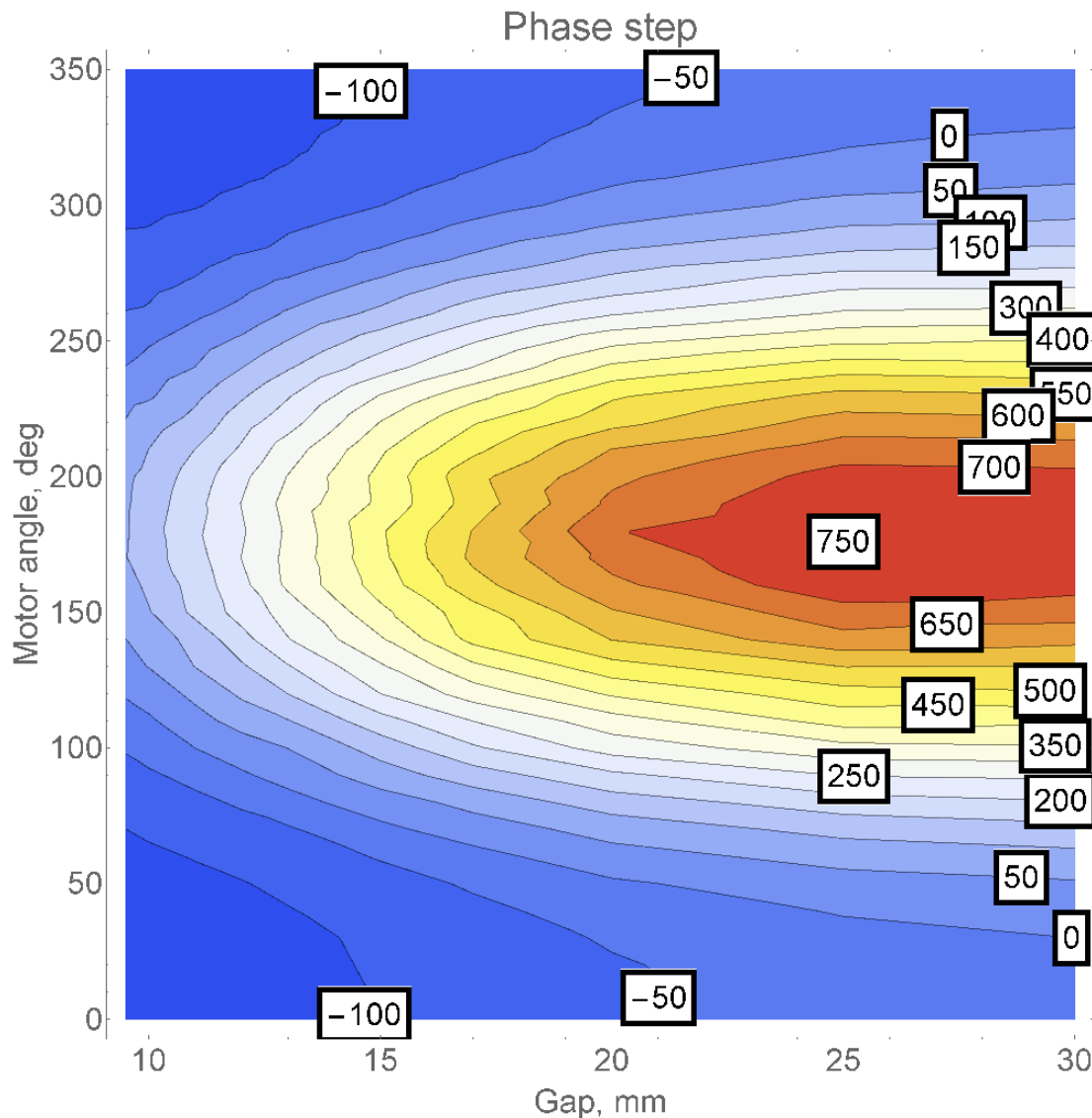

- > Phase step is derived from Hall probe data for all rotation angles and gaps
- > Rotation angles need to be adapted in order to preserve a constant phase when gap is changing



# Phase Adjustment by Outer 4 Motors – Remaining Kick

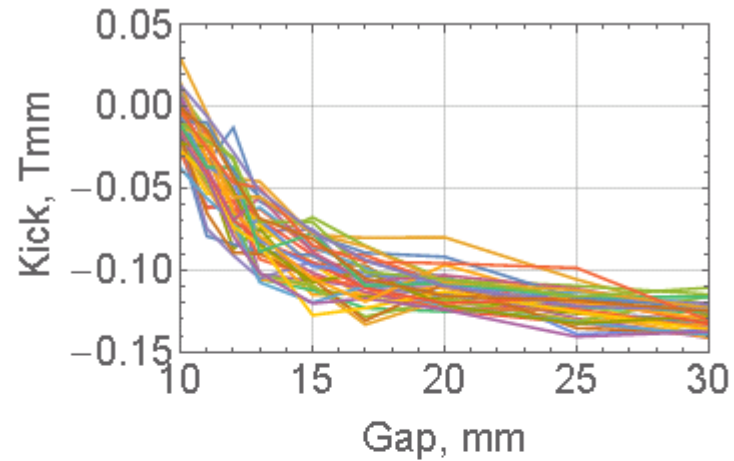
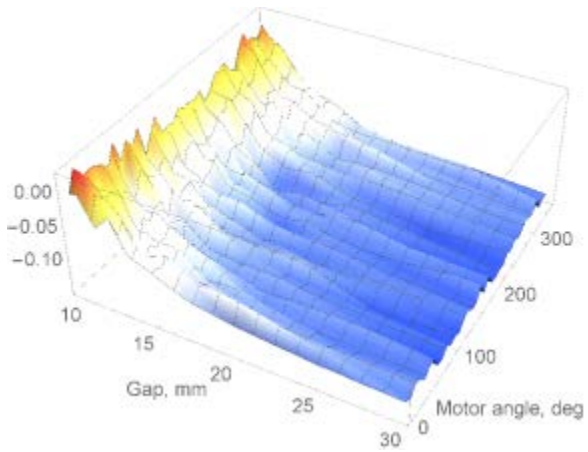
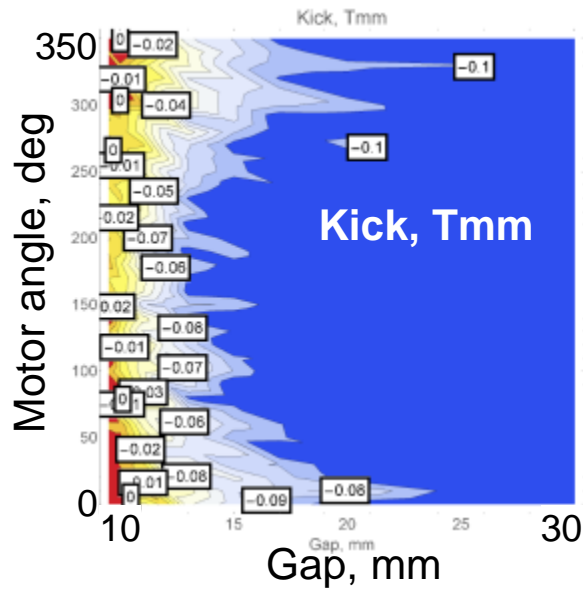

Different angles

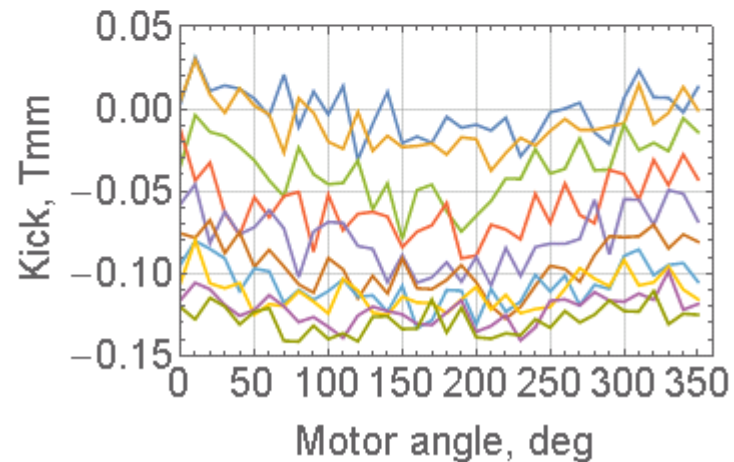

Different gaps

> Kick is dependent only on gap, minor dependence on phase ( $<30\text{Gs}\cdot\text{cm}$ )

# Integral Kick Errors

## > Stretched wire measurements for different operation modes

- Feedforward on the magnet rotation angles adjusts the optical phase shift to a constant value ( $0^\circ$ , or  $\pm 60^\circ$ ) for all undulator gaps

## > Results:

- Remaining kick variations of  $\sim 100\text{Gcm}$  due to gap-dependent end-kick errors
- Agreement between different phase settings  $\sim 10\text{Gcm}$   $\rightarrow$  **no phase shift dependent kick errors**
- Negligible crosstalk into the vertical plane
- Same results for off-axis field integrals

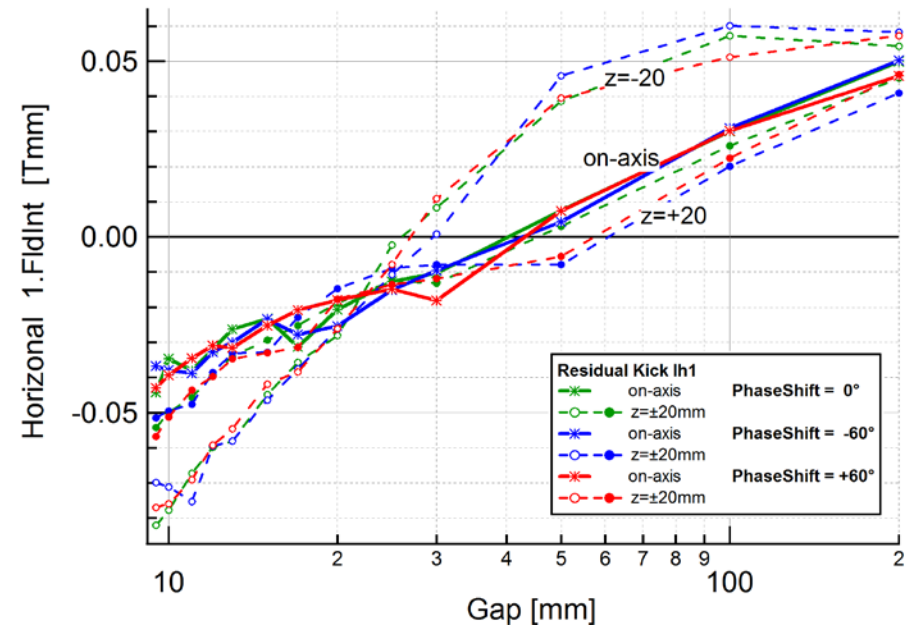
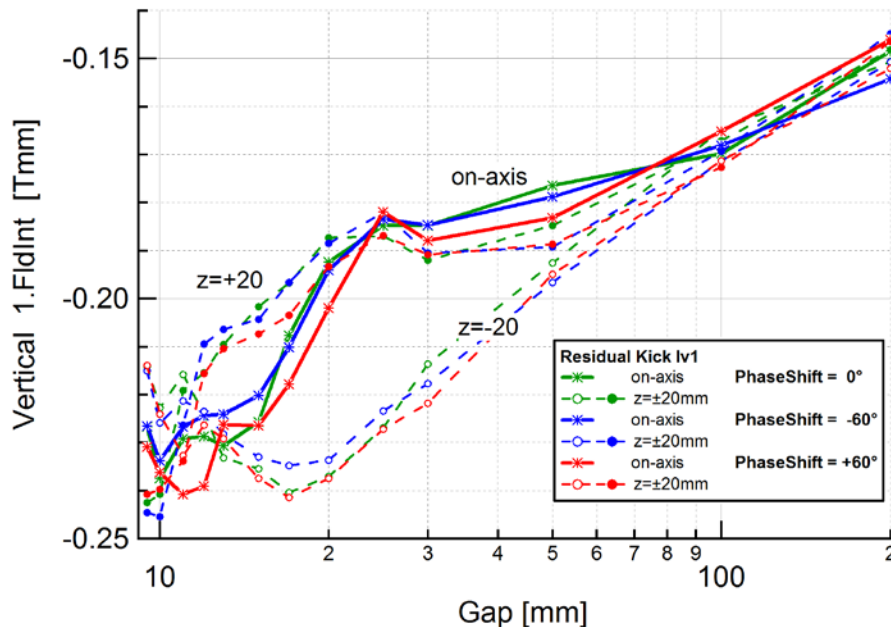

# First Commissioning Results

- > Completion and installation of undulator PU23 in January '17,
- > Initial test with e-beam in mid-May'17
- > Feedforward setting of phase shift motors as function of gap implemented in ID control system for various phase shift values
- > ORM measurements for various settings of **phase shift** and **gap** in order to study Closed Orbit Distortions and to extract **residual kick errors**
- > Results
  - **CODs are promising small!**
  - → refinement of feedforward kick correction ok!
  - no cross-talk to the vertical plane confirmed
- > Investigation of spectral and spatial properties will start in the “next days”... (photon beamline went online last week)

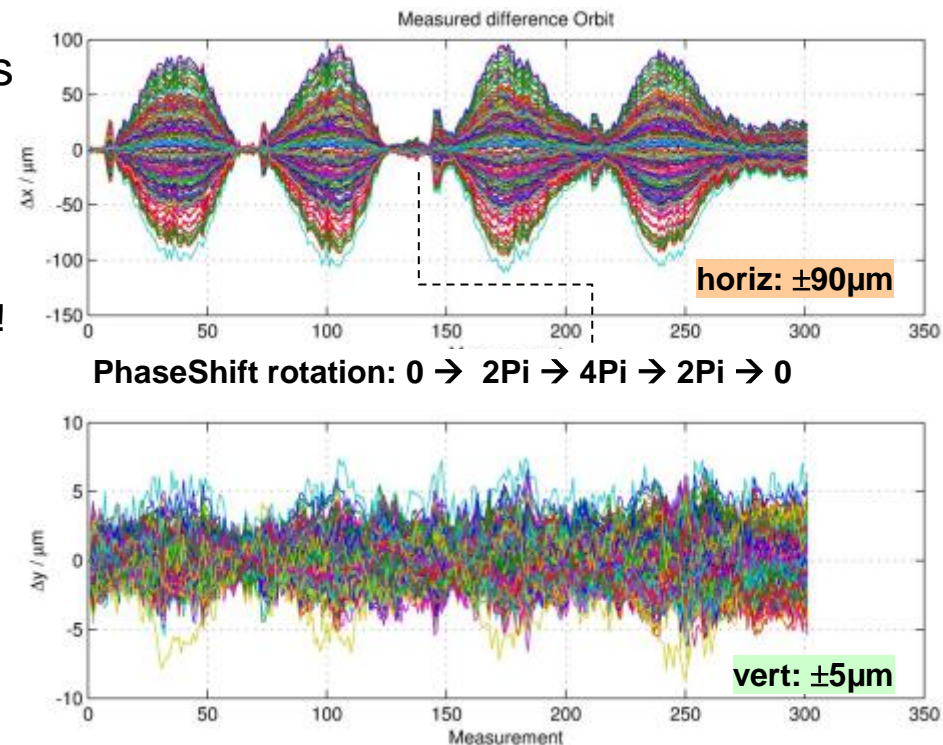
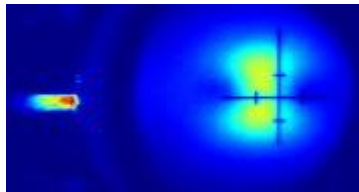

> Thanks!

