



Combination of X-ray Powder diffraction with other techniques

Marco Milanesio

**Dipartimento Scienze e Tecnologie Avanzate
Università del Piemonte Orientale, Alessandria, Italy**

E-Mail: marco.milanesio@mfz.unipmn.it

<http://people.unipmn.it/marcomi>

XI SILS School

Duino Castle (Trieste), September 2011

Summary

Limitation (and possibilities) of (SR) powder diffraction
Definition of “in situ experiments”

PART I: Possible **combination** “*ex situ separated approach*”, XRPD & **NMR** ; XRPD & **HR-TEM** →
structure solution and refinement

Theoretical calculations → better structural models

PART II: Possible *combination at in situ conditions at the synchrotron*: XRPD & DSC, **XRPD & Raman spec.**,
XRPD & IR, XRPD-UV-Vis, XRPD-MS

PART III examples with Raman/XRPD

What information can be obtained with X-ray Powder diffraction (XRPD)

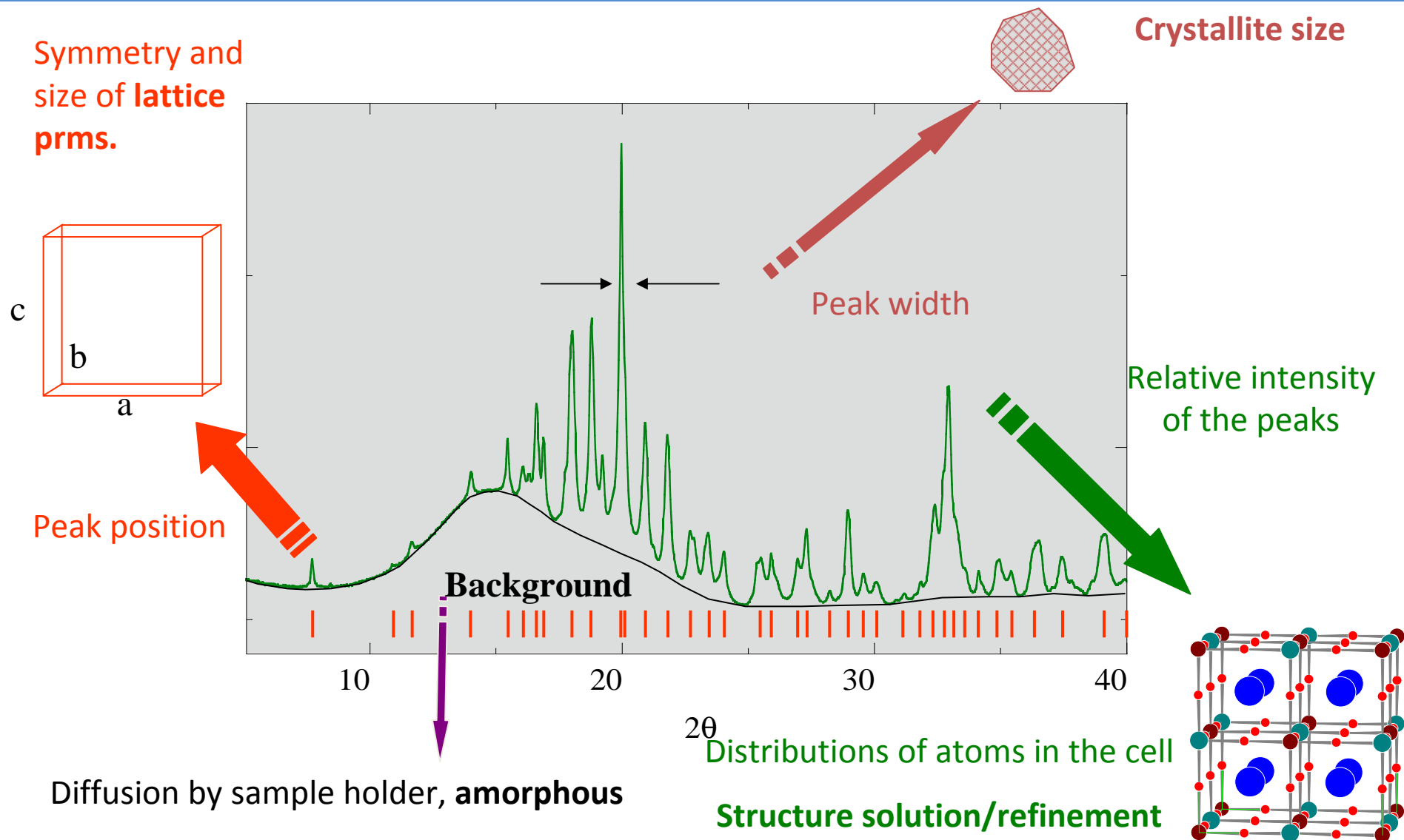

General limitations: what can be NOT be obtained

Energetic features (reaction heats for instance)

Surface properties

Information on gas, liquids **non-periodic** systems in general

Adsorbates

Chemical selectivity (Al. vs. Si, Fe vs. Co etc..) except in case of resonant diffraction experiment (complicate, data analysis not easy)

Electronic properties

.....

...specific limitations of XRPD

Intrinsic limitations

Peak superposition

Decay of I_{DIFFR} with 2θ

Limitations due to the particular case study

Samples of low quality and particular features

Limitations due to experimental setup: in situ & non-ambient

Intrinsic limitation \rightarrow Decay of I_{DIFFR} with 2θ

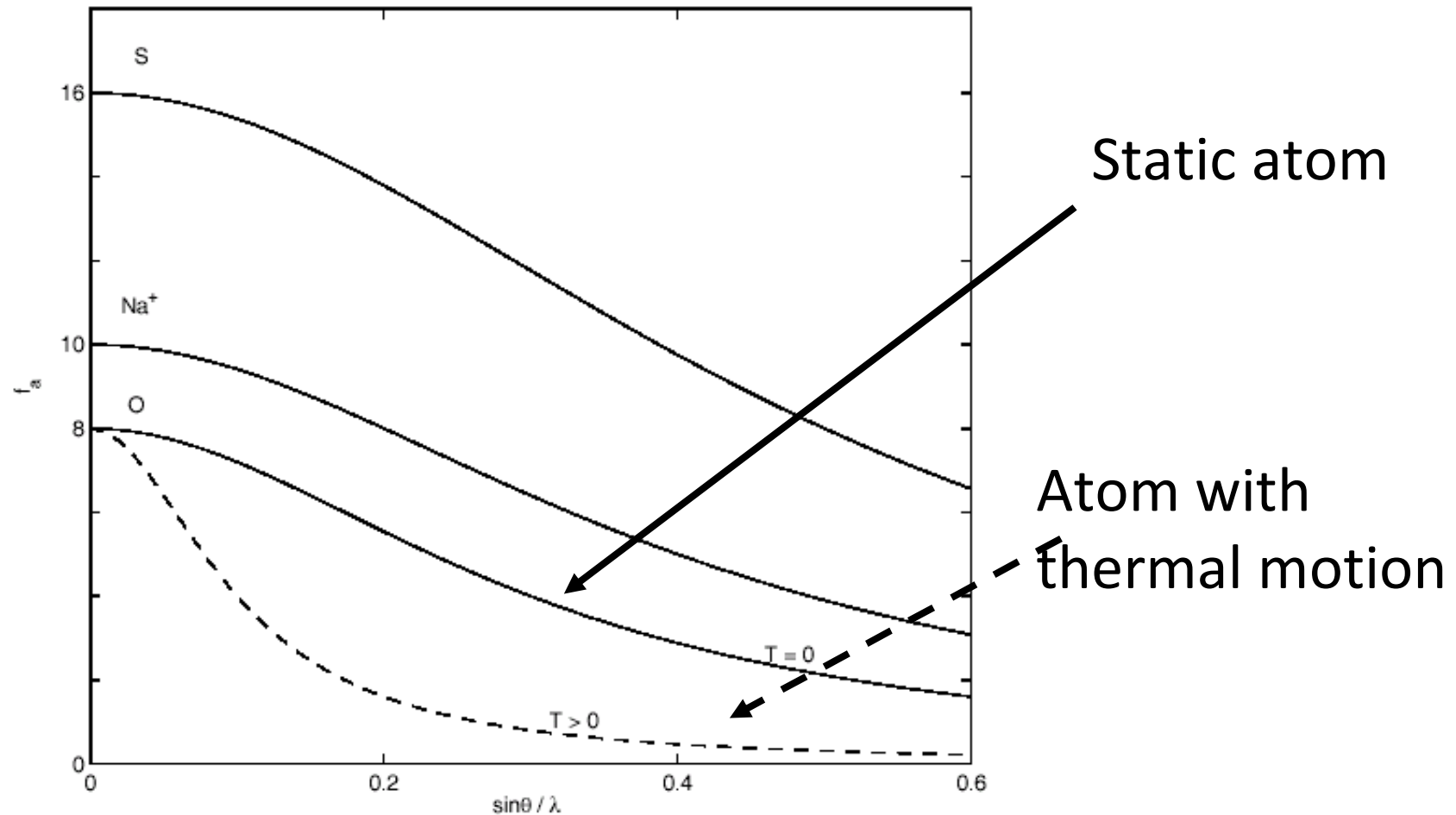

. **PROBLEM:** limited/absent information on light atoms, limitation in resolution for all atoms (see “diffraction by crystalline materials,)

Intrinsic limitation of XRPD: peak superposition

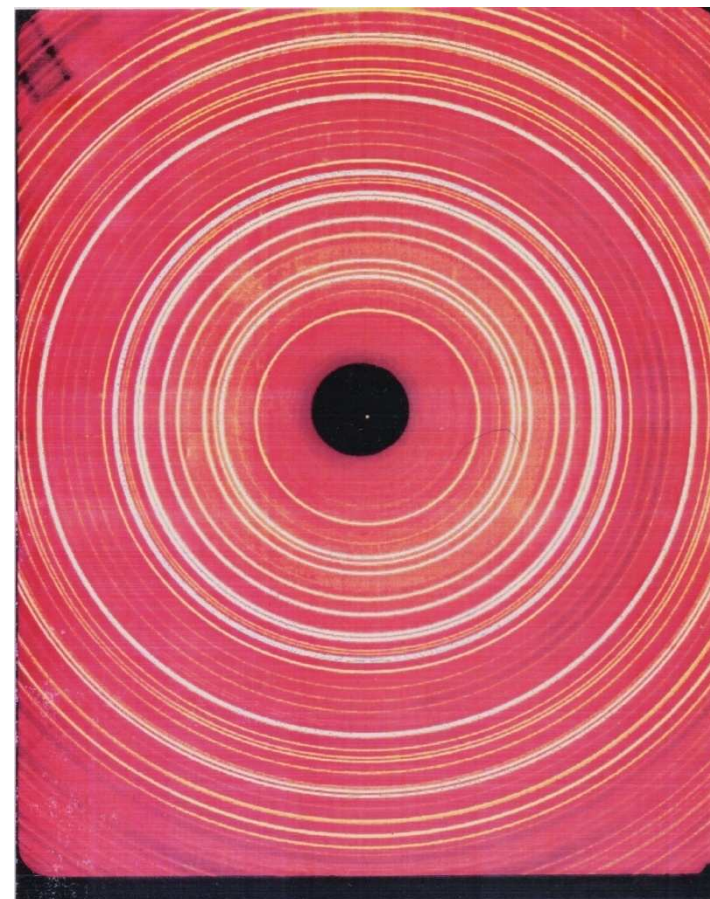
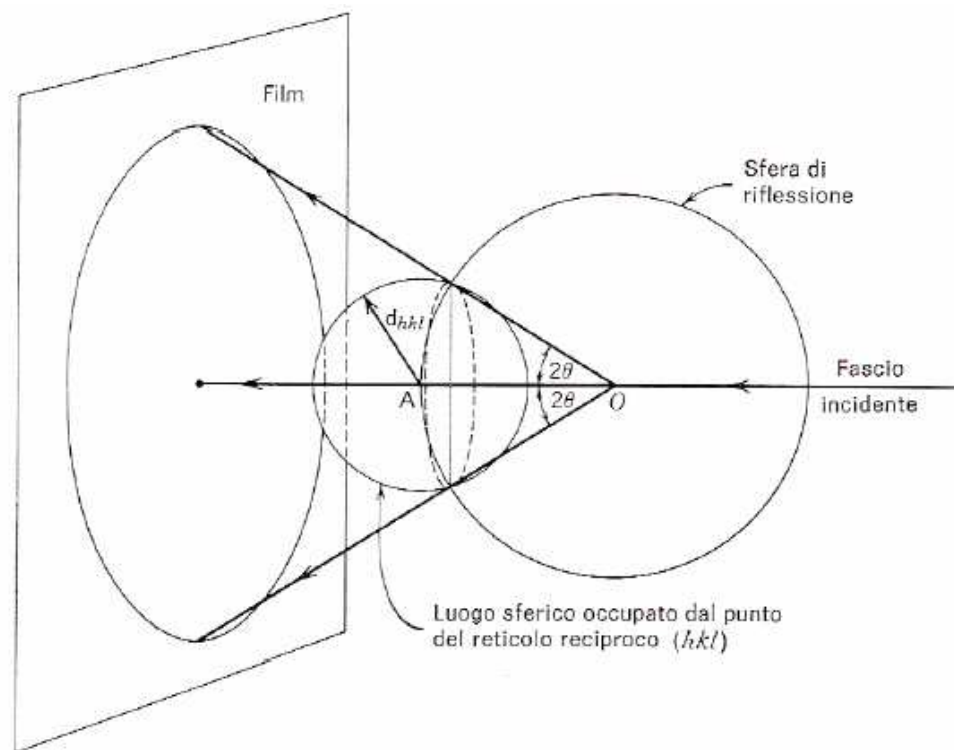

Peak superposition due to the collapse of the reciprocal 3-D space in 1-D XRPD pattern

Peak superposition - examples

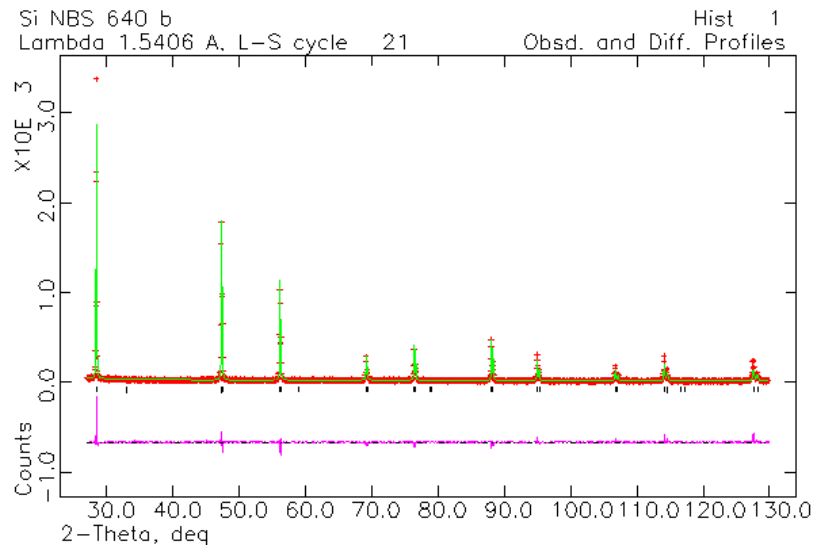

Silicon standard – limited
problem

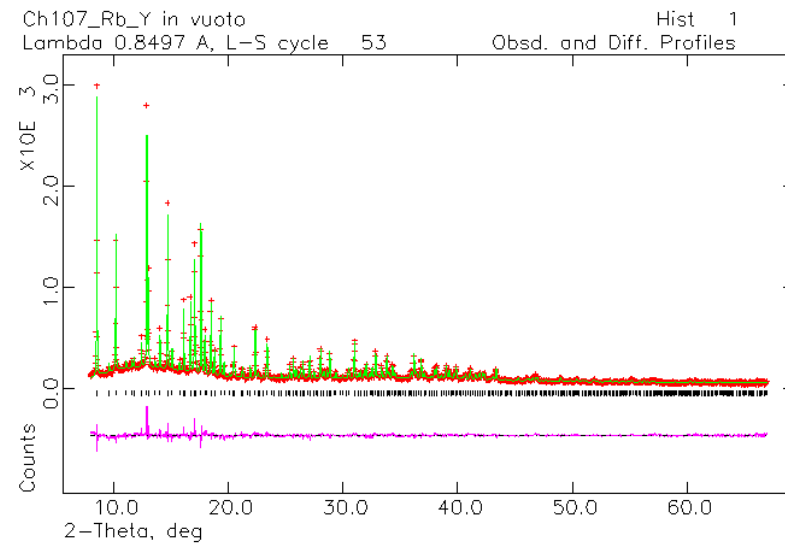

Real sample, a zeolite –
dramatic problem

PROBLEM: poorer data/parameter ratio, very limited resolution at high angles (see “diffraction by crystalline materials”)

Difficulties and very few information on the structural features with:

Nanoparticles

Disorder

Light elements

Impurities

Defects

....

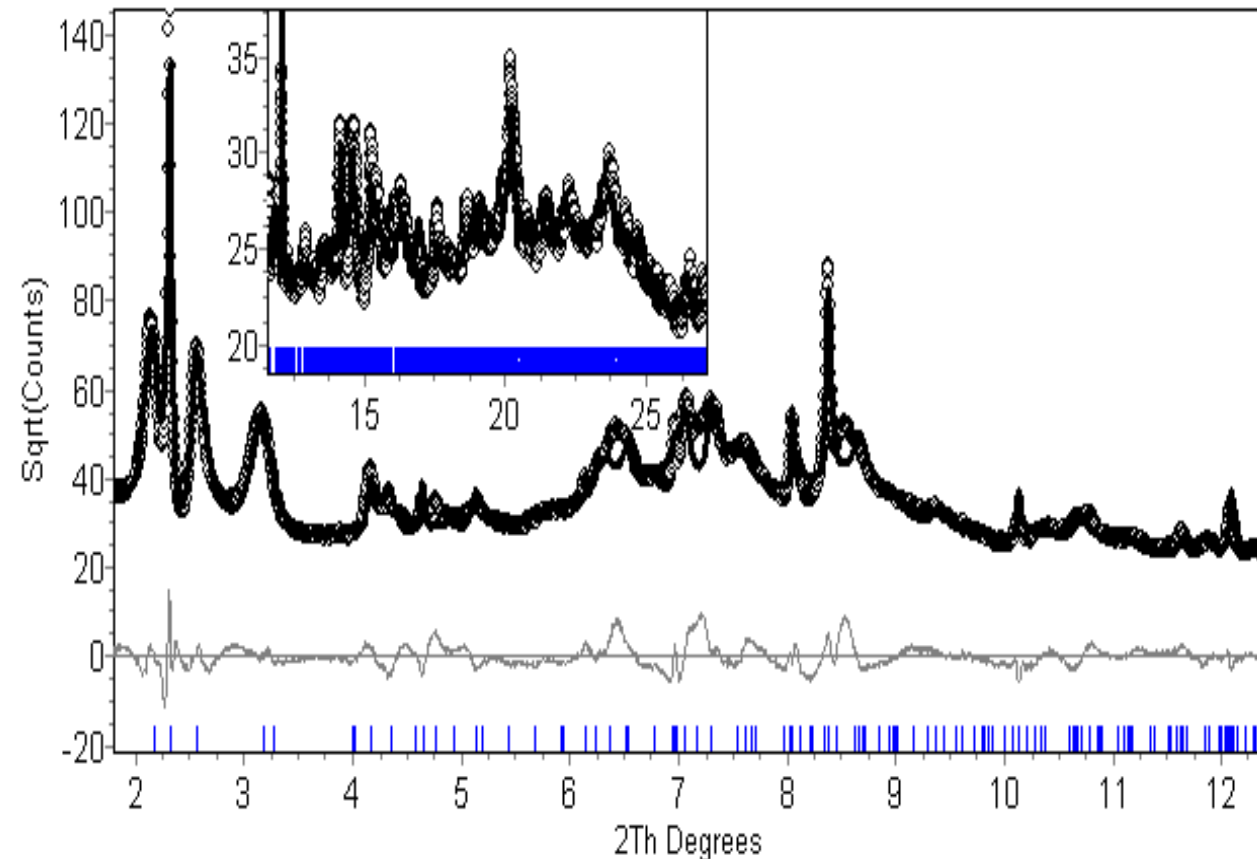

Limitations due to the experimental setup

Gas feed line: O₂,
H₂O, N₂, CH₃OH etc.

*In situ XRPD with gas flux
(Gilda at ESRF, Grenoble)*



Catalyst

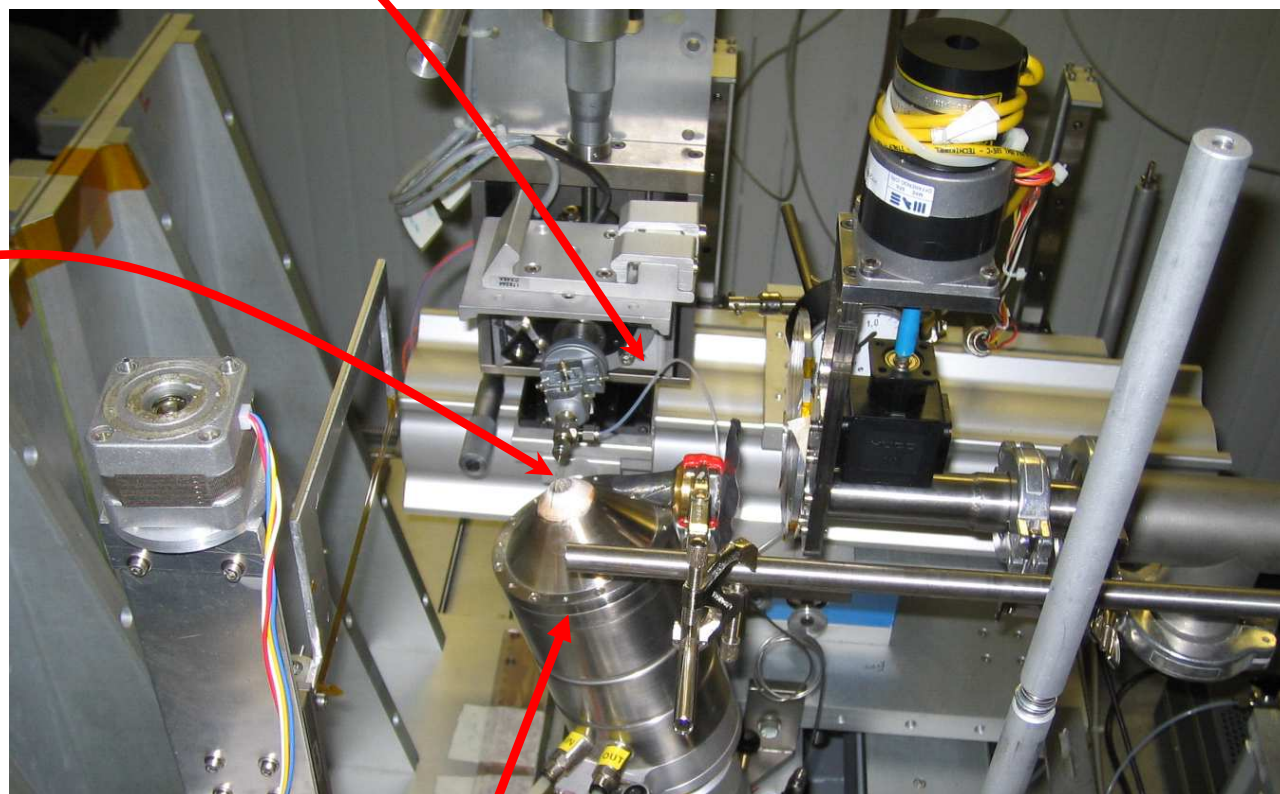

The reactor
(0.7 mm quartz capillary)

Heat gun

•G. Agostini et al., *J. Am. Chem. Soc.*, 2010, 132 (2), 667

Limitations due to the in situ experimental setup...

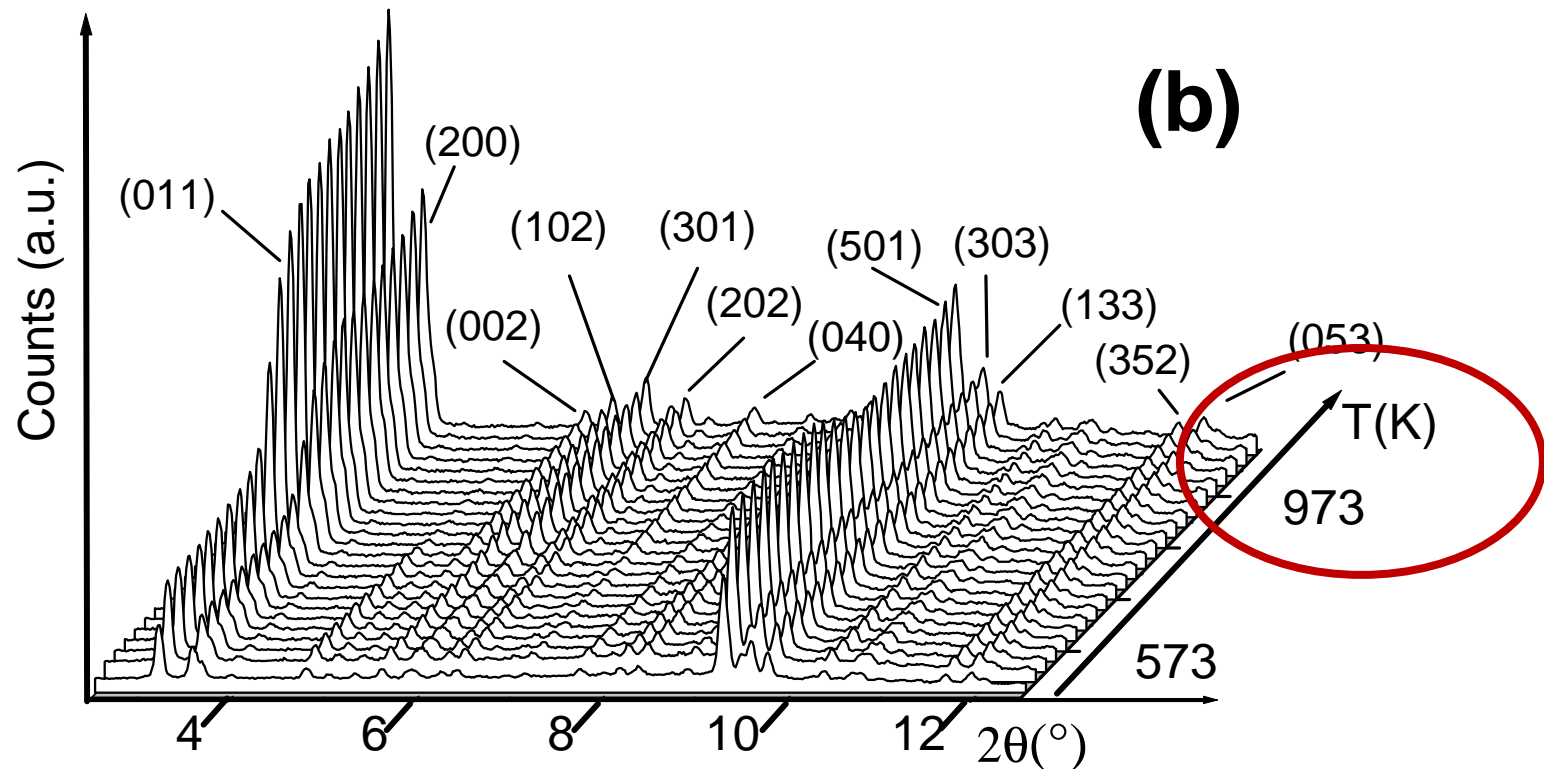

Limitations in 2θ and angular resolution and lower S/N ratio because of sample environment equipments, of detector designed/used to measure faster ($<$ sampling time). In the **dynamic measurement** the data collection time must be smaller of the evolution time of sample

...combining limitations due to the case study

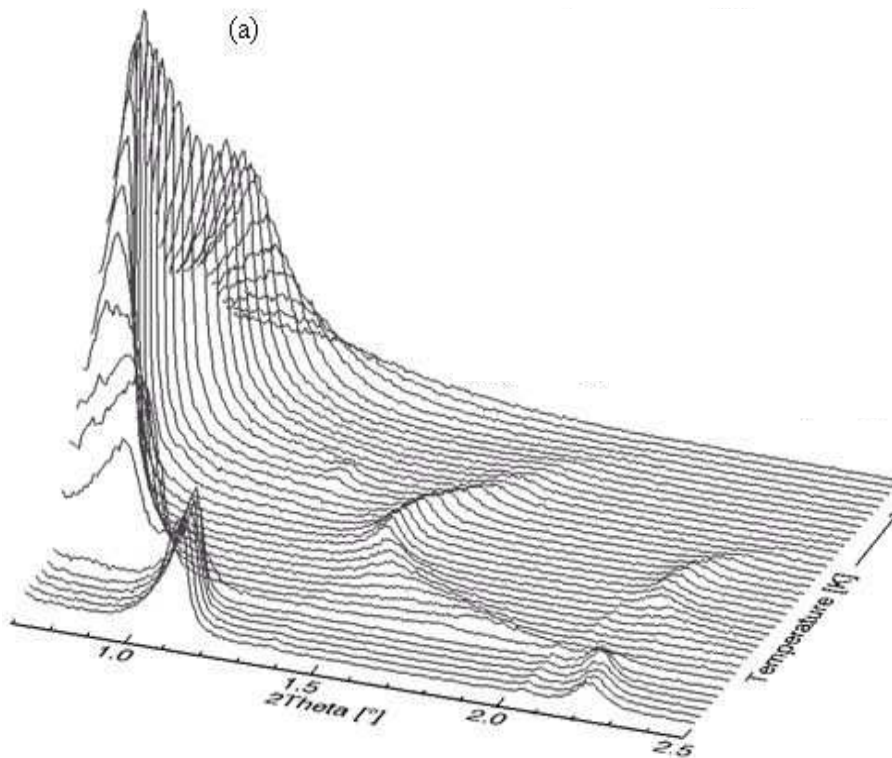

•E. Boccaleri, *J. Appl. Cryst.*, **2007**, *40*, 684-693.

Samples of low quality and particular features: layered materials with peaks only in low 2θ region (exchanged hydrotalcite)

Small crystallite \rightarrow broader peaks \rightarrow more superposition

All previous problems become more important/dramatic!

Definition of in situ and non-ambient conditions

Static measurements

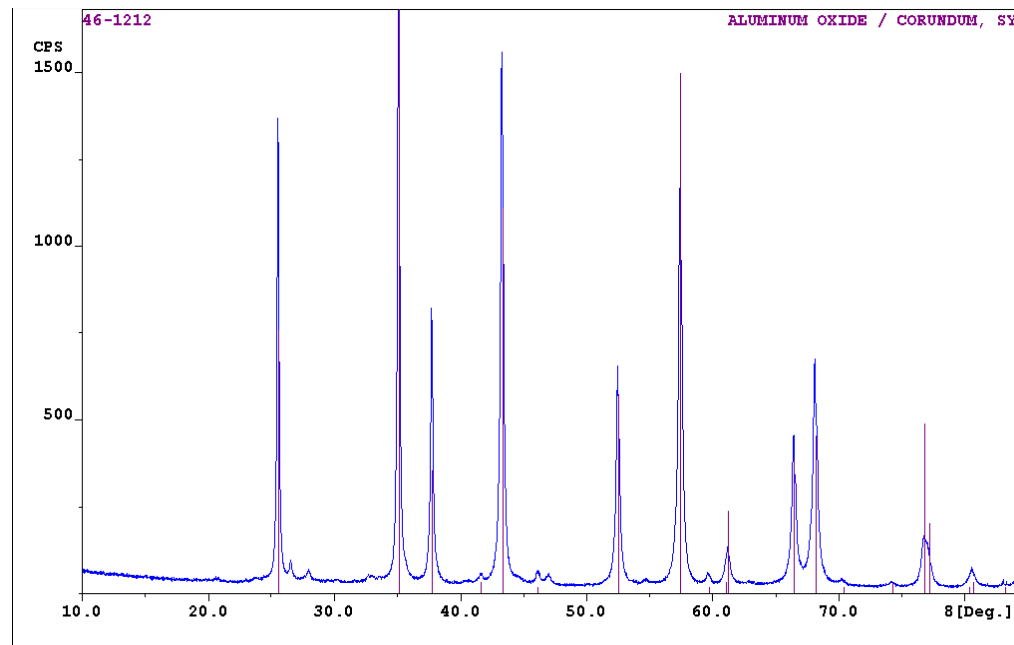

In the **static measurement** the data collection time affects only the data accuracy

The larger the data collection time, The larger the accuracy (counting statistic, better Signal/Noise ratio etc)

Time-resolved in situ measurements

In principle every technique can be used to study a sample showing an evolution during because of an external stimuli → **in situ** or **NON static measurement**

The necessary condition is that the **data collection time** is **smaller** with respect to the rate of the **changes**

This approach is defined *in situ* (i.e. “measurement carried out on the evolving sample) at **non-ambient** conditions (T, P, gas, photoirradiation etc) with a **time resolved measurement** (i.e. the data collection is able to appreciate the changes of the samples)

What's the added value?

All the information of the technique are available **during the reaction/transformation advancement**

The sample can be studied in the **real situation** of formation/application understanding its response to **external stimuli**

The **bias** due to the static approach study of a dynamic process are eliminated (for instance the transformation occurring **after** a sample is extracted from the reactor to carry out a static meas. (**dead sample**) are eliminated

From now on we'll speak about ***in situ* powder diffraction** but this approach can be used with every techniques

Studying the behaviors of a piece of metallic/ceramics during its life into an engine

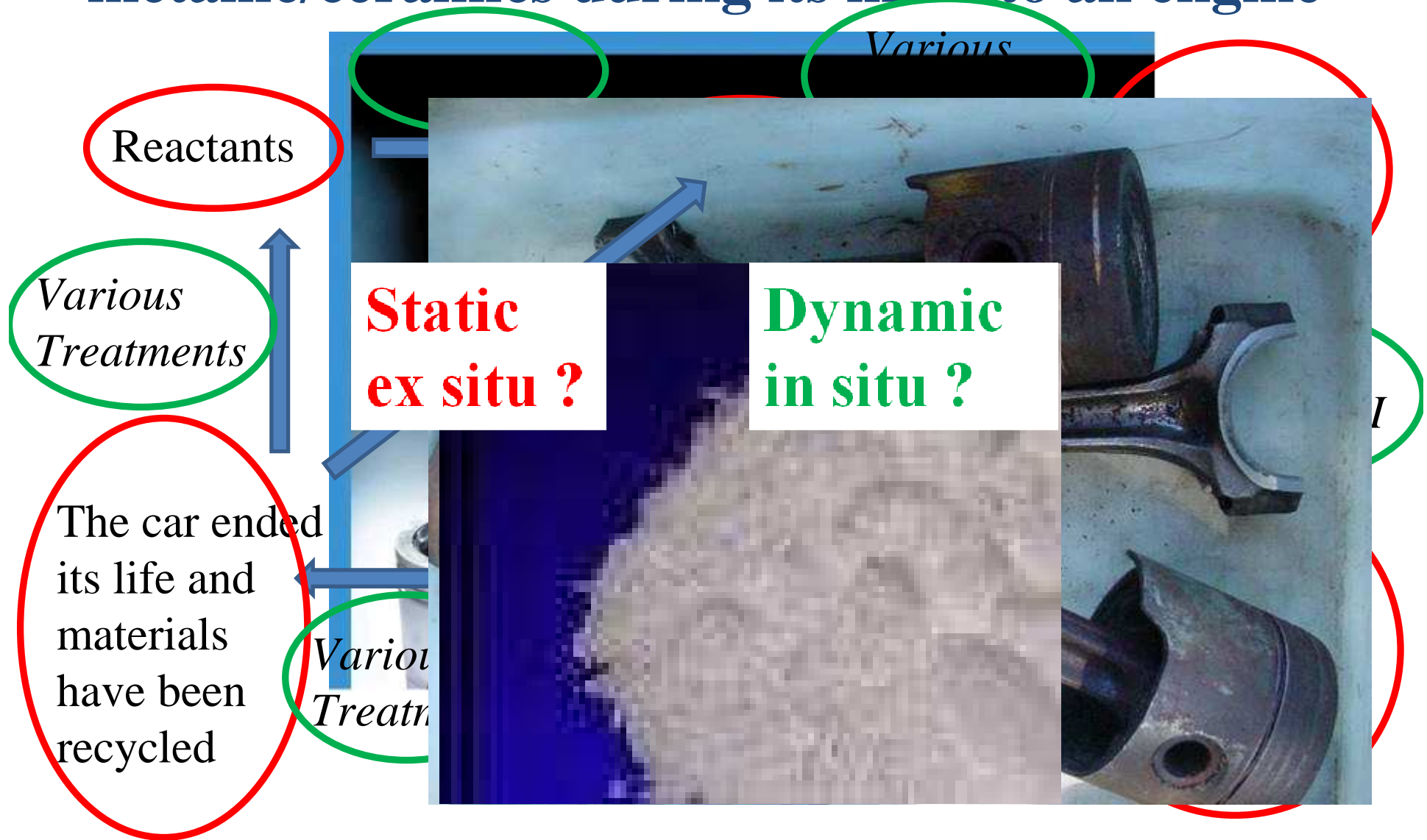

To overcome limitations: complementary techniques

Microscopy techniques:

HR-TEM & Electron Diffraction (crystal structure solution),
SEM (crystallite size)

Spectroscopy techniques

SS-NMR: structure solution, defect states

Raman spec.: surface effects, disordered/light atoms, information
at the interaction level

Infrared spec.: adsorbed species, surface properties, hydration
species

Mass spec.: gas identification and quantification

UV-Vis spec.: electronic states

OTHER techniques

Thermo gravimetry/DSC, Dynamic light scattering, SAXS, ...
depending on the studied system!

Summary

Limitation (and possibilities) of (SR) powder diffraction
Definition of “in situ experiments”

PART I: Possible combination “*ex situ separated approach*”, XRPD & NMR ; XRPD & HR-TEM → structure solution and refinement

Theoretical calculations → better structural models

PART II: Possible *combination at in situ conditions at the synchrotron*: XRPD & DSC, XRPD & Raman, XRPD & IR, XRPD-UV-Vis, XRPD-MS

PART III examples with Raman/XRPD

XRPD & SEM: overcoming the lack of chemical sensitivity

Complementary information about elemental analysis and purity/homogeneity of the phase

fundamental for crystal structure solution and refinement

Element	C	N	O	Na	Al	Si	Cl
Mole fraction %	19,61	1,52	47,03	0,95	2,31	28,11	0,47

Complementary information to crystallite size analysis:

- particle size probing
- amorphous/gel phases
- Homogeneous sample

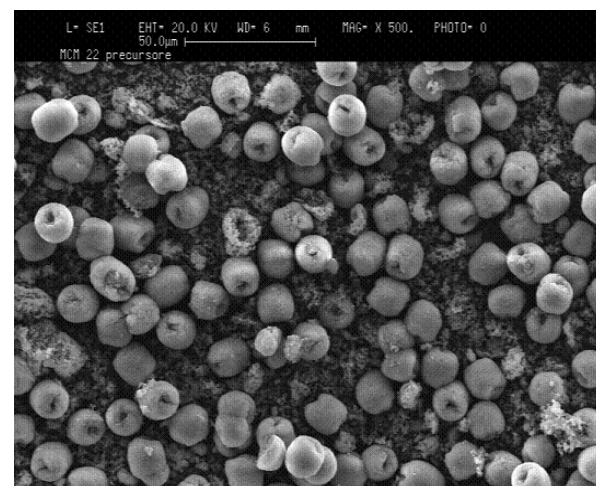

Overcoming superposition and 2theta limitation of XRPD – Solid-state NMR

Structure solution by XRPD often hampered by problems in indexing and/or space group assignment

SS-NMR can give fundamental information:

Number of independent atoms in the asymmetric unit → SG assignment/ best cell choice

Coordination of atoms → information on connectivity to help model building

Presence of disorder (NMR signal broadening)

SS-NMR-assisted refinement:
Roux et al., *Microporous and Mesoporous Materials* 63 (2003) 163–176

Marco Milanese

SS-NMR-assisted structure solution: Jordà et al., *Microporous and Mesoporous Materials* 65 (2003) 43–57

Overcoming superposition and 2theta limitation of XRPD II – High resolution TEM I

HR-TEM: imaging can give direct information on cell size/parameters, connectivity

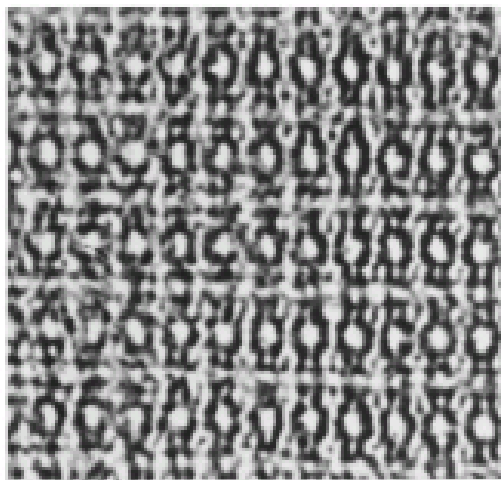

TEM image

← A
← C
← A
← C

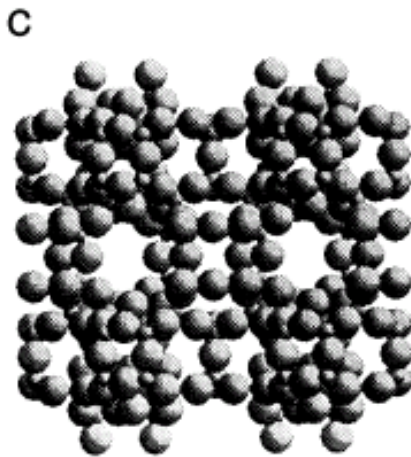

Model building

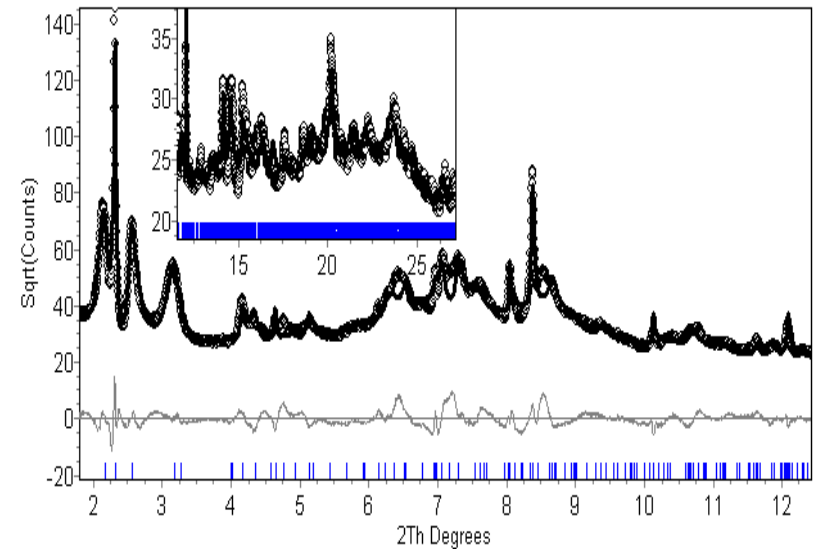

Rietveld refinement

Leonowicz et al., *Science* 1994, 264, 1910.

Lawton et al., *Microporous and Mesoporous Materials* 23 (1998) 109–117

Overcoming superposition and 2theta limitation of XRPD – High resolution TEM II

HR-TEM in diffraction → “single crystal” (of few nm size)
electron diffraction:

Smaller crystallites **MUST** be used

Direct phasing: phase can be obtained

Sample preparation data collection MUCH MORE complicated!!!

But Kinematic approximation (see Zanotti lecture) NOT valid

Xie et al., J. Appl. Cryst. (2008). 41, 1115–1121

Direct phasing by PED (precession electron diffraction)

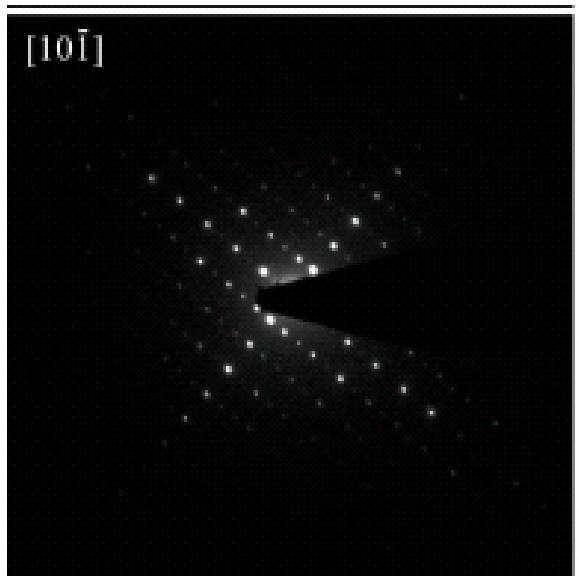

Intensity directly measured

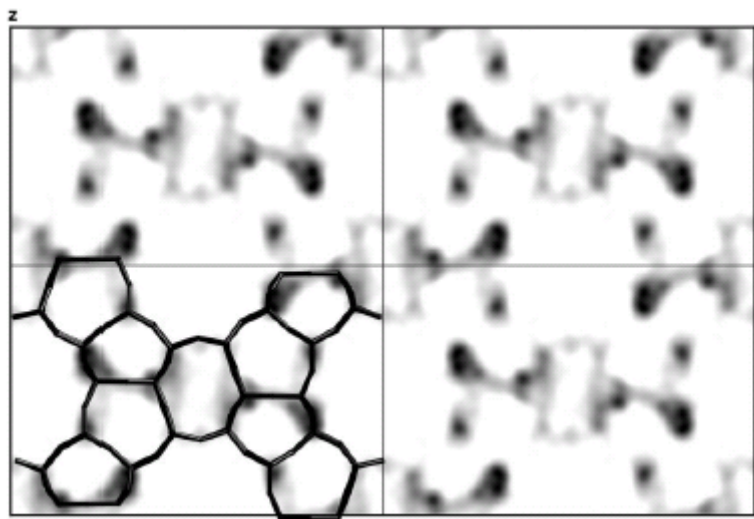

Electron density map obtained & model building

Rietveld refinement of XRPD (Synchrotron?) data to obtain a reliable model

Direct phasing by Automated diffraction

Real Space Tomography

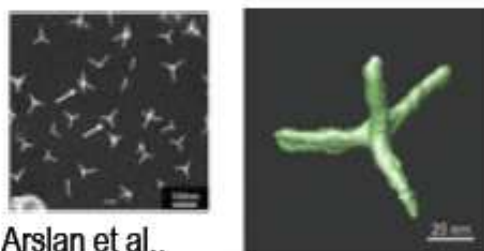

Arslan et al.,
Ultramicroscopy **106**,
994–1000 (2006)

Reciprocal Space Tomography

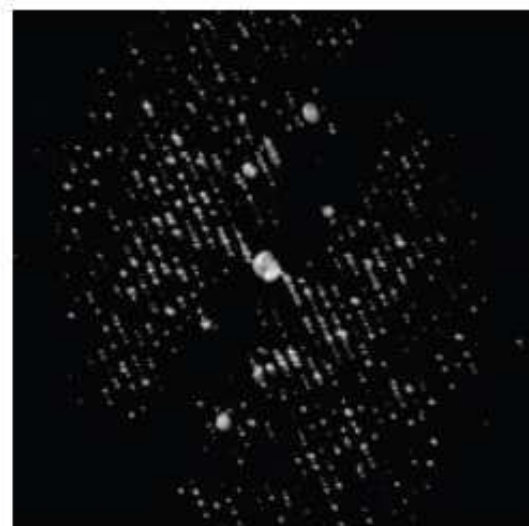

$\pm 60^\circ = 121$ diffraction patterns
Approx. 2h data collection time

3D reconstructed reciprocal
space

Towards automated diffraction tomography. Part I - Data Acquisition

U. Kolb, T. Gorelik, C. Kübel, M.T. Otten and D. Hubert, *Ultramicroscopy*, **107**, 507-513 (2007).

ADT – 3D reconstruction and cell parameter determination

3D reconstruction



Difference vector space

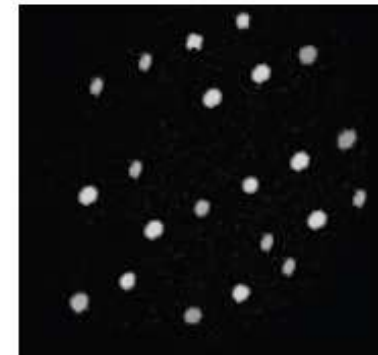

Autocorrelation of 3D volume



Clustering routines

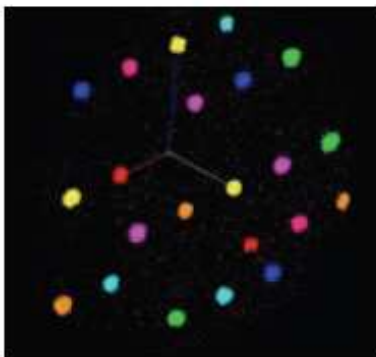

Cell parameter determination:

- Error of approx. 2-5%
- triclinic cells directly accessible



Towards automated diffraction tomography. Part II – Cell parameter determination
U. Kolb, T. Gorelik and M.T. Otten, *Ultramicroscopy*, **108**, 763-772 (2008).

Complementarities of precession electron and X-ray powder diffraction

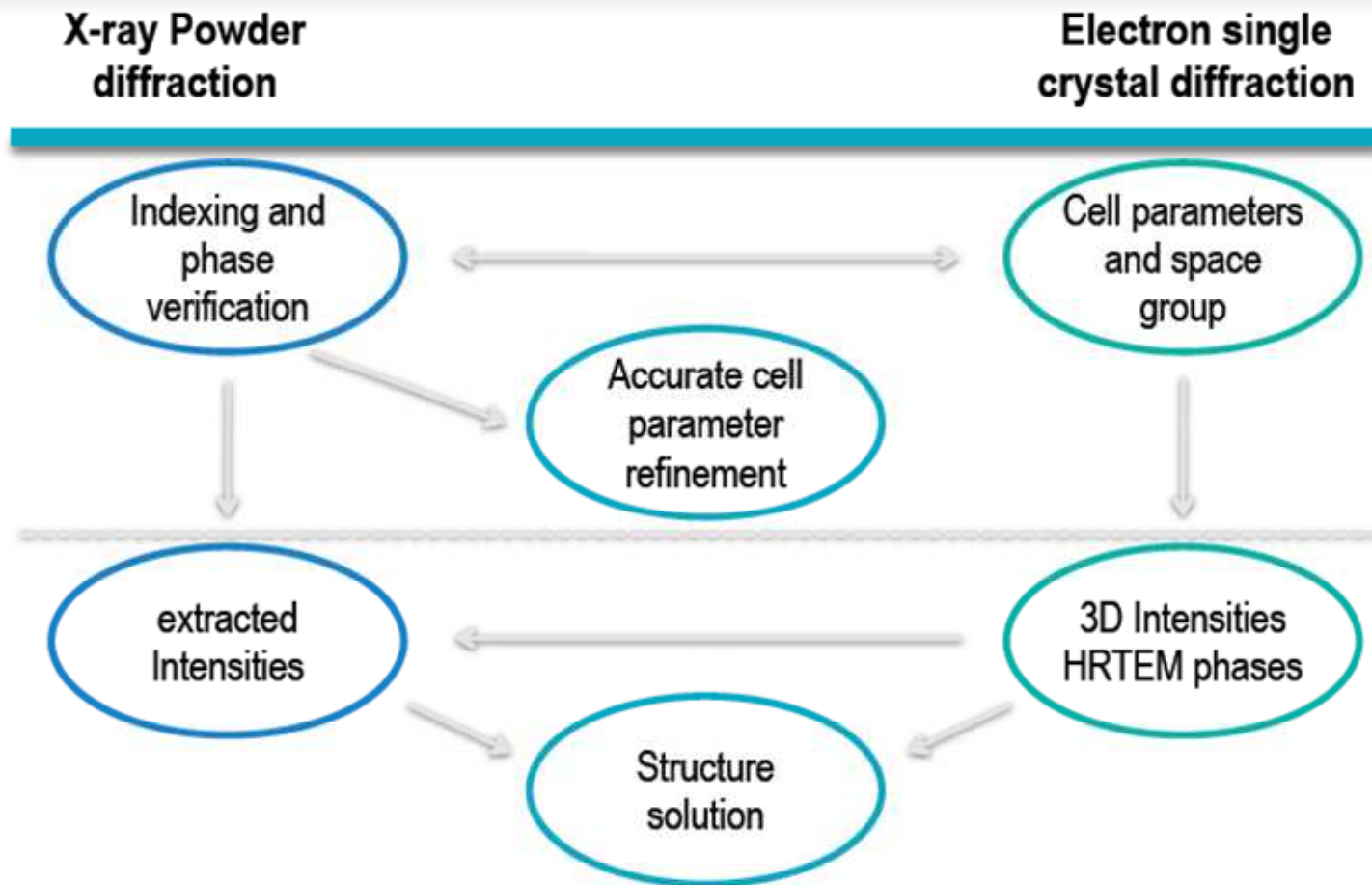

Impact on structure solution (with and without electron beam precession)

Only approx. 50 structures solved by electron diffraction at all



Additional 30 structures solved by ADT in 2 years

Diffraction data quality:

Completeness of diffraction space

- ~70% triclinic
- ~90% monoclinic

Resolution: ~0.08 nm organics
~0.06 nm inorganics

Average deviation of atomic positions (comparison ADT - X-ray): ≤ 0.01 nm

Good detectability of light atoms

Sample applicability:

Smallest crystal used:

- ~300 nm organics
- ~ 20 nm inorganics

Largest analysed volume: 33000 \AA^3

Largest number of independent atoms: 90

Agglomerated and embedded samples

Polyphasic materials



Slides about ADT from A. Stewart, Un. Mainz.

References:

Synthesis of a new Zn_{1+x}Sb nanophase and its structure determination by electron diffraction, Ch. S. Schade, E. Mugnaioli, T. Gorelik, U. Kolb, M. Panthöfer, W. Tremel, *J.A.C.S.* **132(28)** 9881---9889 (2010)

**The structure of charoite, (K,Sr,Ba,Mn)₁₄--
-16(Ca,Na)₃₂[(Si₇₀(O,OH)₁₈₀](OH,F)_{4.0} * nH₂O, solved by conventional and automated electron diffraction**, I. Rozhdestvenskaya, E. Mugnaioli, U. Kolb, W. Depmeier, M. Czank, A. Reinholdt, T. Weirich, *Mineral. Magazin* 74(1), 159--177 (2010)

Elucidating Gating Effects for Hydrogen Sorption in MFU-4 Type Triazolate-based MOFs Featuring Different Pore Sizes D. Denysenko, M. Grzywa, M. Tonigold, B. Schmitz, I. Krkljus, M. Hirscher, E. Mugnaioli, U. Kolb, J. Hanns and D. Volkmer *ChemistryEur* **17(6)**, 1837-1848 (2011)

Overcoming superposition and 2theta limitation of XRPD– Theoretical calculations I

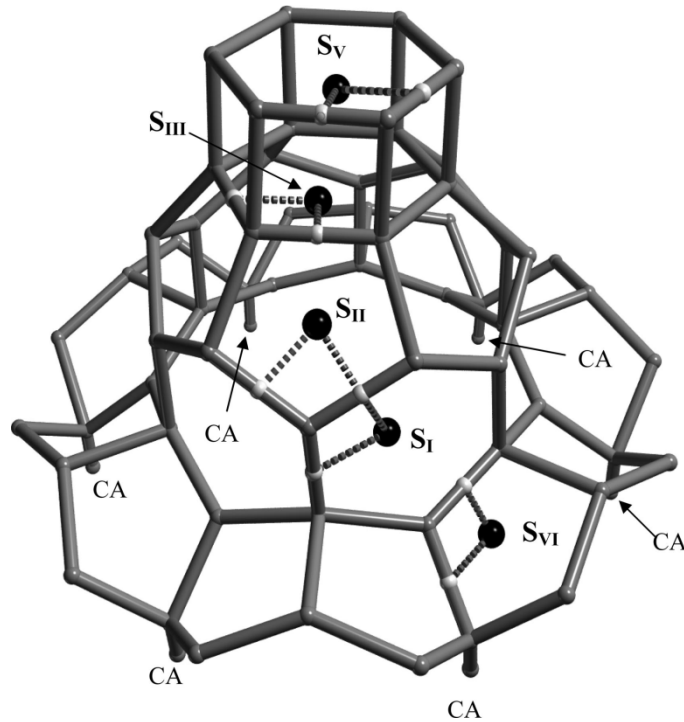

Theoretical calculation
can start from rough
model from XRPD data
and obtain a better
model

XRPD data refinement can give limited information on geometric parameters: distances, angles, local environment because of intrinsic problems and sample features (disorder, layered morphology etc.)

Cu site	LAV3P*	Cu–O distances (Å)
Id	0.0	2.27, 2.36, 2.42, 2.53, 2.71
IIb	5.0	2.20, 2.39, 2.66, 3.16
III	10.9	2.26, 2.40, 2.46, 2.60, 2.82
Ia	22.6	2.16, 2.53, 2.55, 2.85, 2.88
Ib	30.6	2.25, 2.38, 2.39, 2.55
VIb	32.9	2.18, 2.19, 3.14, 3.53
VIc	53.4	2.25, 2.35, 2.44, 2.63
IIc	55.0	2.18, 2.19, 2.34, 2.99
IIa	62.9	2.19, 2.25, 2.61, 3.35
Ic	94.5	2.18, 2.47, 2.52, 3.12
VIa	113.7	2.14, 2.42, 2.45, 3.58

Overcoming superposition and 2theta limitation of XRPD– Theoretical calculations II

*Calculation to ameliorate the XRPD model (previous slide)
Milanesio et al., J. Phys. Chem. A, 2008,112 (36), pp 8403–
8410.*

BUT ALSO:

*Calculation to obtain information not accessible by XRPD:
MCM-22 acidity study Wang et al., J. Phys. Chem. B 2004, 108,
1386-1391*

Summary

Limitation (and possibilities) of (SR) powder diffraction
Definition of “in situ experiments”

PART I: Possible combination “*ex situ separated approach*”, XRPD & NMR ; XRPD & HR-TEM →
structure solution and refinement

Theoretical calculations → better structural models

PART II: Possible ***combination at in situ conditions at the synchrotron***: XRPD & DSC, XRPD & Raman, XRPD & IR, XRPD-UV-Vis, XRPD-MS

PART III examples with Raman/XRPD

PART II

Possible combination at in situ conditions → simultaneous experiments

Reason why “in situ & simultaneous”

XRPD & DLS

XRPD & DSC

XRPD & IR

XRPD-UV-Vis

XRPD & MS

XRPD & Raman

Combination of techniques at in situ conditions in catalysis:

Tinnemans et al., *Catalysis Today* 113 (2006) 3–15 and references therein

M.A. Newton and W. van Beek, *Chem. Soc. Rev.*, 2010, 39, 4845

Motivation for combining XRPD with other techniques at the synchrotron

Overcoming the limitations of XRPD

✓ disordered moieties

✓ light elements ($Z < 4$)

✓ gel phases

✓ liquid phases

✓ nanoparticles

✓ surface reactivity

✓ amorphous phases

✓ evolved gas

Why Simultaneous combination with XRPD?

Because of the perfect space, time and reaction-coordinate correlation between the additional probe and XRPD and no bias due to different sample holder/conditioning modes

- Many non-simultaneous X-ray diffraction and spectroscopic studies have been performed for their complementarities.
- *In situ* induced sample modifications with multiple external stimuli such as:
 - Temperature and/or
 - Pressure and/or
 - UV or Visible Light, X-ray's and/or
 - Oxidizing or reducing environments
 -
- On samples that show **kinetic** and **non-reversible behaviors** on one or more of these stimuli

**Difficult or impossible to synchronize separate
XRPD and Raman experiments**

Complementary information:

- Information on molecular structure: single and double bonds, molecular groups, organic molecules structure etc
- Information at the interaction level
- Surface sensitivity
- Information on light atoms
- Information of disordered, amorphous, gel, liquid phases
- Information on protonation/hydration states

Complications:

- Optic much more complex (IR transparent materials, i.e. KBr etc) not easy to build/maintain lens, sample holder windows etc

XRPD & IR (similar to Raman but much more complicated)

XRPD can not probe (or give very few information) on nitrogen especially at in situ conditions (neither Raman because of symmetry)

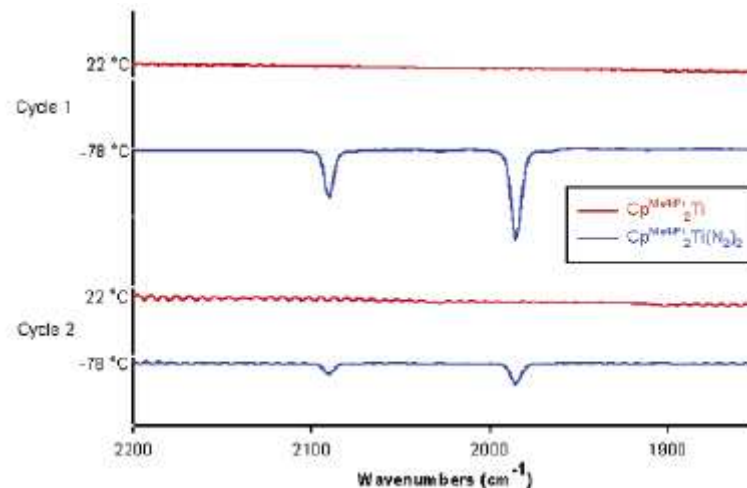
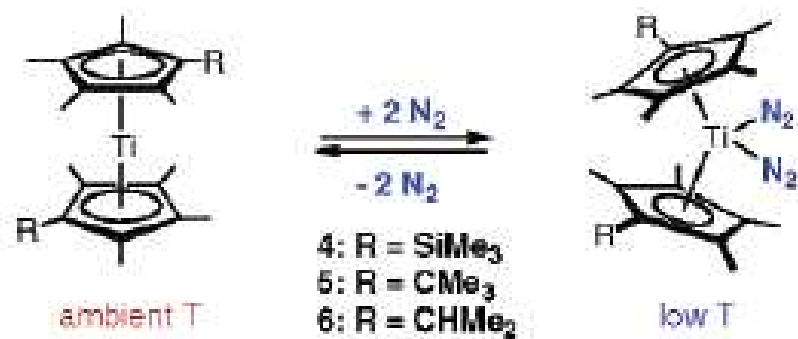

IR spectroscopy can detect nitrogen attached to Titanium atom

Hanna et al., J. AM. CHEM. SOC. 2004, 126, 14688-14689

XAFS & UV-Vis (but also suitable for XRPD/UV-Vis) I

NOTE: setup without optic fibres

Complementary information:

- Electronic structure
- Sensitivity to molecular environment

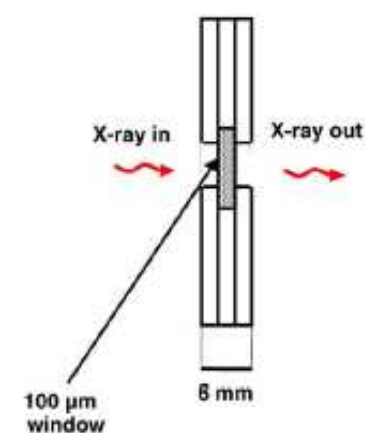
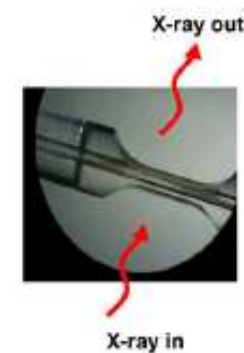
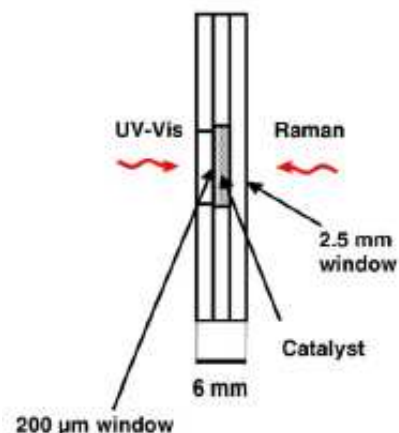
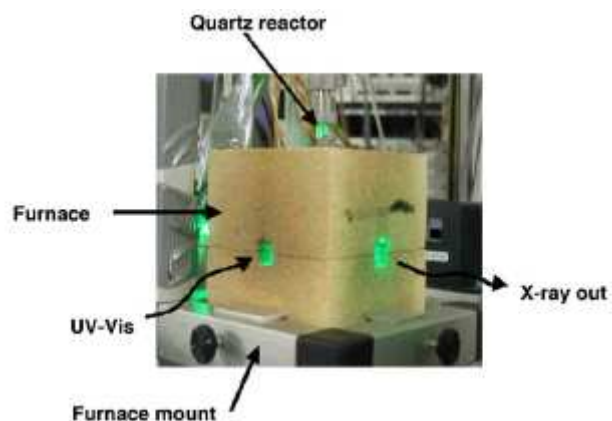
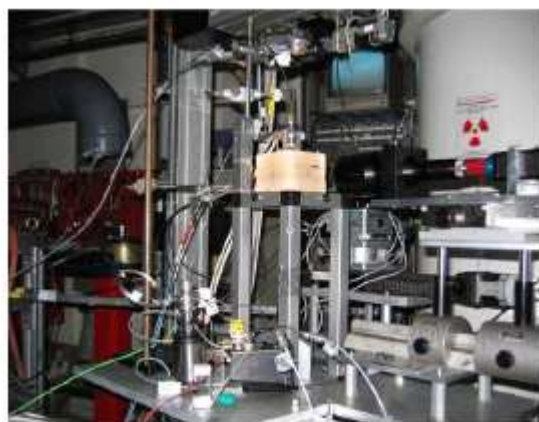

Studied system:

Mo/SiO₂ catalyst during propane dehydrogenation

UV-Vis information:
electronic structure of the
sample, quality and quantity
of particular species (also in
the liquid state, depending
on the setup)

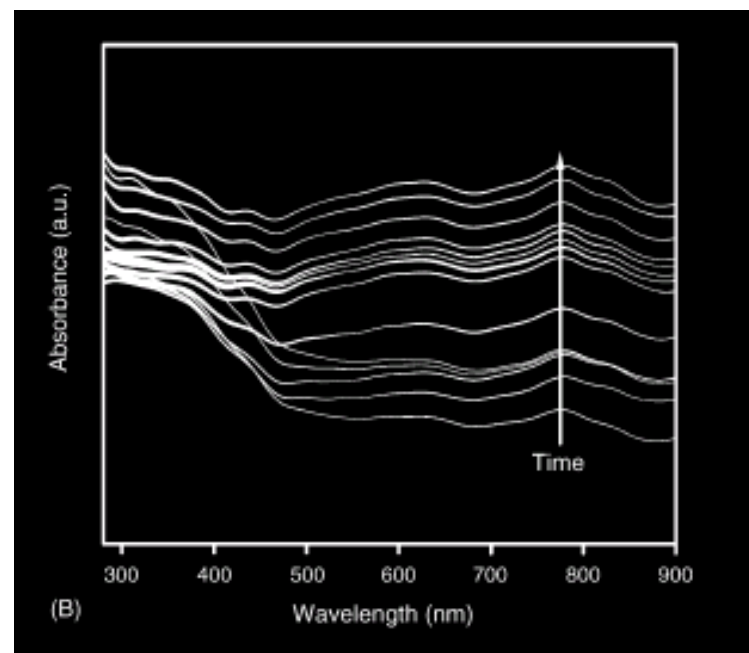

Complementary information:

- Short range order (coordination properties, “local” ADP)**
- Chemical sensitivity, single atomic species probed!**

1) I.J. Shannon, T. Maschmeyer, G. Sankar, J.M. Thomas, R.D. Oldroyd, M. Sheehy, D. Madill, A.M. Waller, R.P. Townsed, *Catal. Lett.* 44 (1997) 23.

2) J.W. Couves, J.M. Thomas, D. Waller, R.H. Jones, A.J. Dent, G.E. Derbyshire, G.N. Greaves, *Nature* 354 (1991) 465.

3) B.S. Clausen, L. Grabaek, G. Steffensen, P.L. Hansen, H. Topsoe, *Catal. Lett.* 20 (1993) 23.

4) J.D. Grunwaldt, A.M. Molenbroek, N.Y. Topsoe, H. Topsoe, B.S. Clausen, *J. Catal.* 194 (2000) 452.

XRPD & Mass Spectroscopy

Complementary information:

- Gas composition after interaction with the sample

High-Temperature Oxidation of Bismuth Sulfide Using TPO-MS and in Situ XRPD (in situ but separated!)

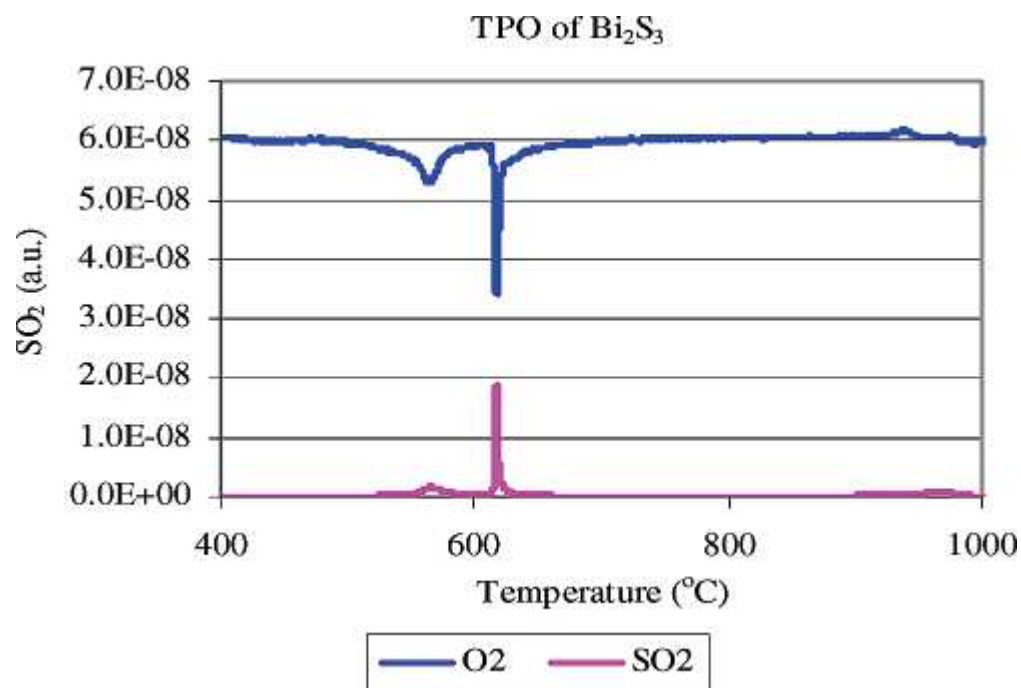

Consumed oxygen and produced SO₂ not accessible to XRPD at all!

Johnson et al., *Ind. Eng. Chem. Res.* **2004**, *43*, 3127-3132

XRPD & Dynamic Light Scattering (DLS)

Complementary information to crystallite size analysis (measuring also amorphous part):

- particle size probing also with amorphous/gel phases or crystal nuclei

XRPD & DLS Artioli , et al., *Stud. Surf. Sci. and Catal.*, Part A&B, **2002**, *142*, 45-52.

XRPD & Differential Scanning Calorimetry (DSC)/Thermogravimetry

Complementary information:

- Gravimetric/energetic information on phase transitions

Use of a DSC stage as XRPD sample holder:

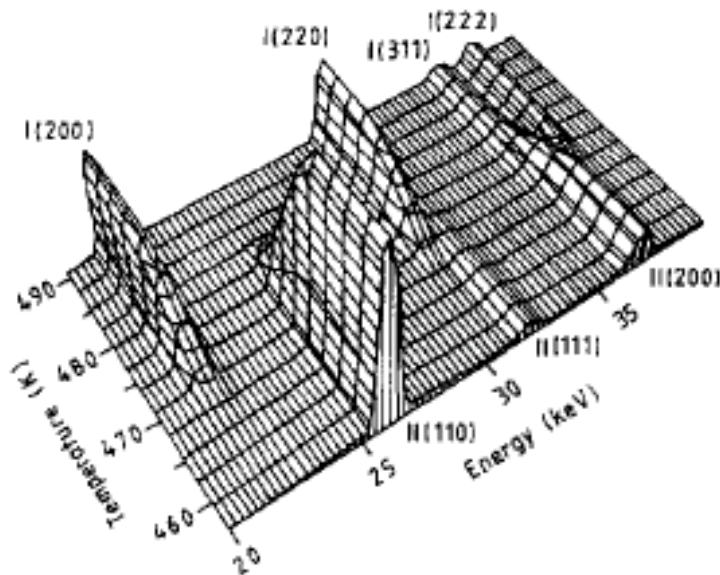

Structure transition from XRPD

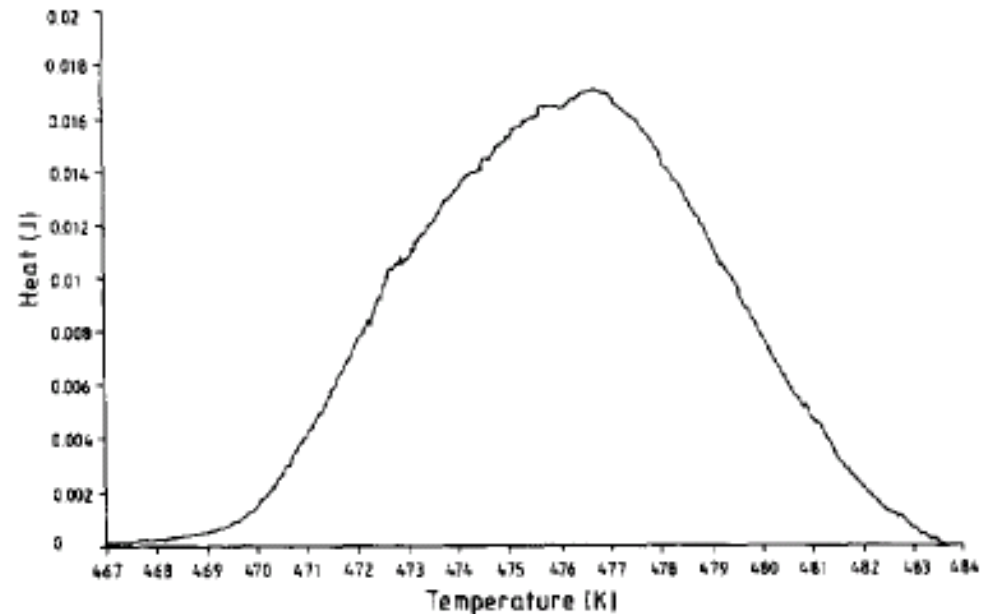

Energy change (heat flow) by DSC

XRPD & DSC/Thermogravimetry II

A reaction path can be followed by both XRPD (structure) and DSC (energy)

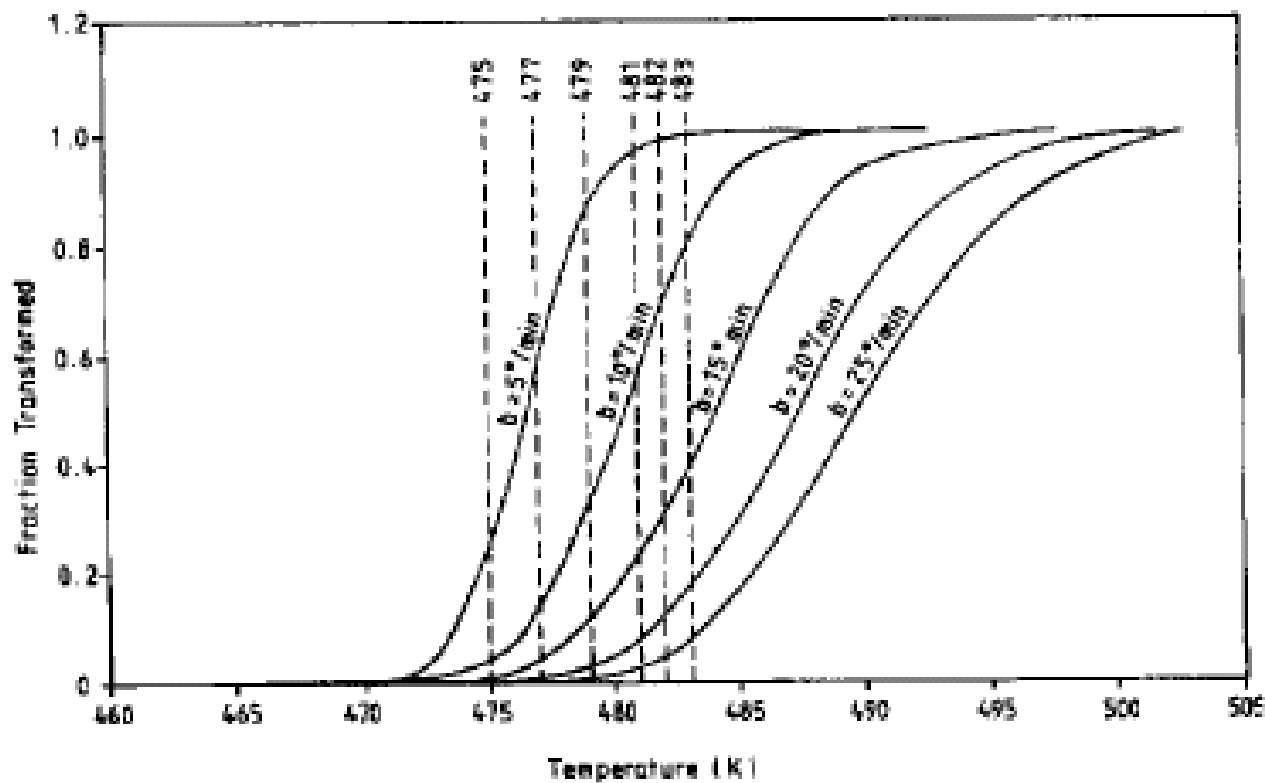

Kennedy & Clark, *Thermochimica Acta*, 307, 1997, 27-35.

Complementary information:

- Information on molecular structure: single and double bonds, molecular groups, organic molecules structure etc
- Information at the interaction level
- Surface sensitivity
- Information on light atoms
- Information of disordered, amorphous, gel, liquid phases

A simultaneous Raman-XRPD facility has been designed and realized to exploit the complementarities of the two techniques in investigating *in situ* solid-state phase transitions, occurring at non-ambient conditions.

The Experimental Set-up – Technical details

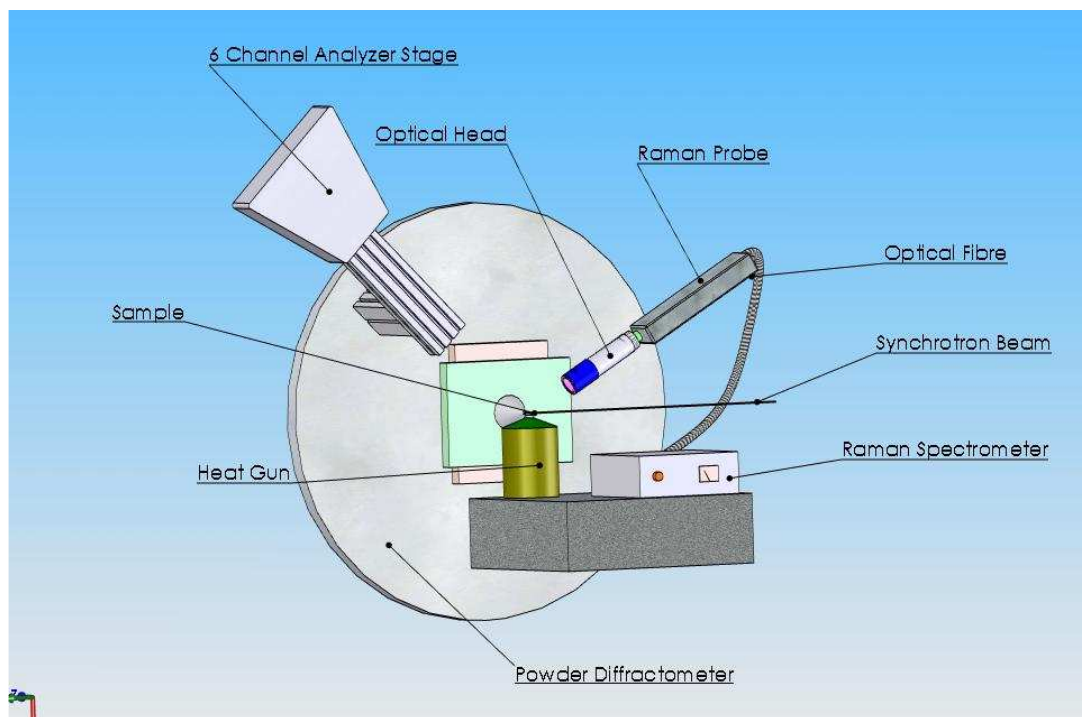

Raman/XRPD *in situ* alignment:

- The time synchronization of the Raman and XRPD detectors and of the heating gas blower was obtained by collecting data in continuum and by recording the time/temperature of each measurement.

- **More info:** E. Boccaleri, F. Carniato, G. Croce, D. Viterbo, W. van Beek, H. Emerich and M. Milanesio, *In situ simultaneous Raman/high-resolution X-ray powder diffraction study of transformations occurring in materials at non-ambient conditions*, J. Appl. Cryst. (2007), 40, 684-693.

The Experimental Set-up

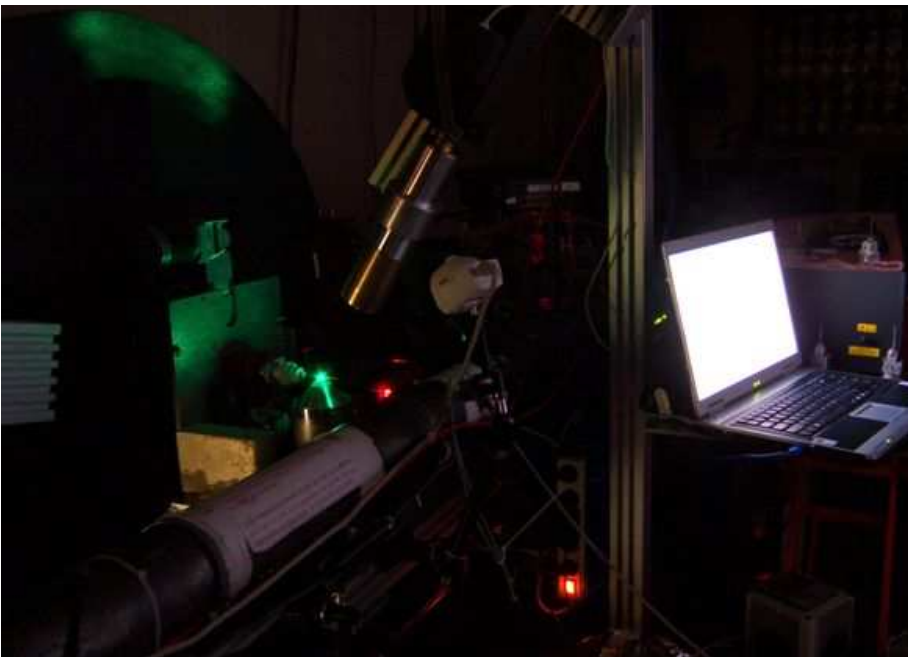
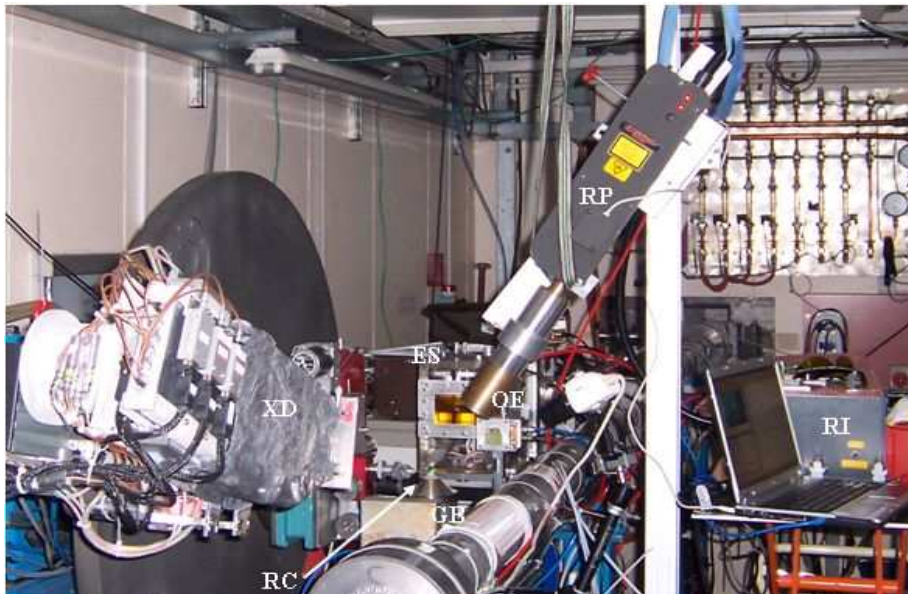

Some clear and dark views ...

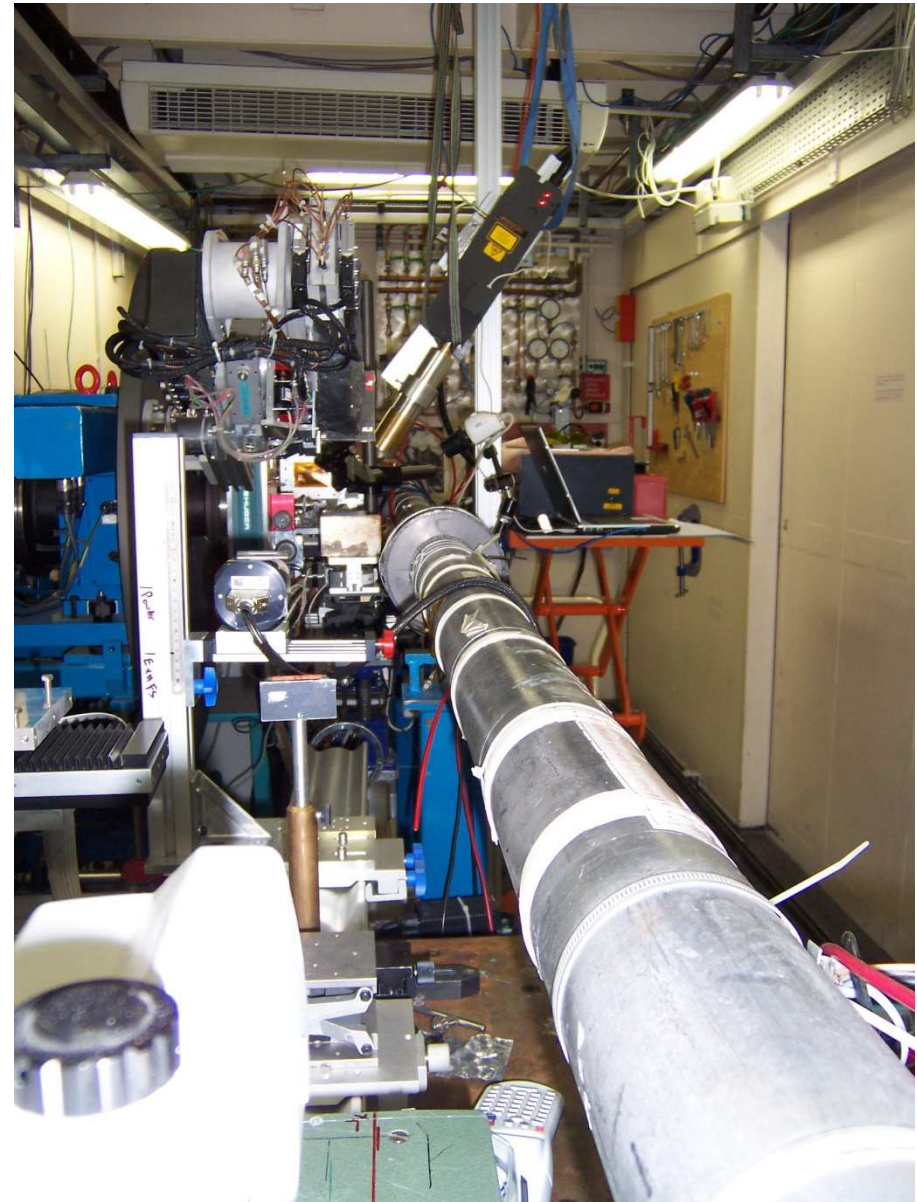

The Raman instrument (June 2007)

A Renishaw In-Via Raman fibre optic spectrometer has been installed and tested.

Raman measurements can be performed off-line and in the two SNBL experimental stations. Two high power lasers are available: VIS/NIR 785nm and 532nm.

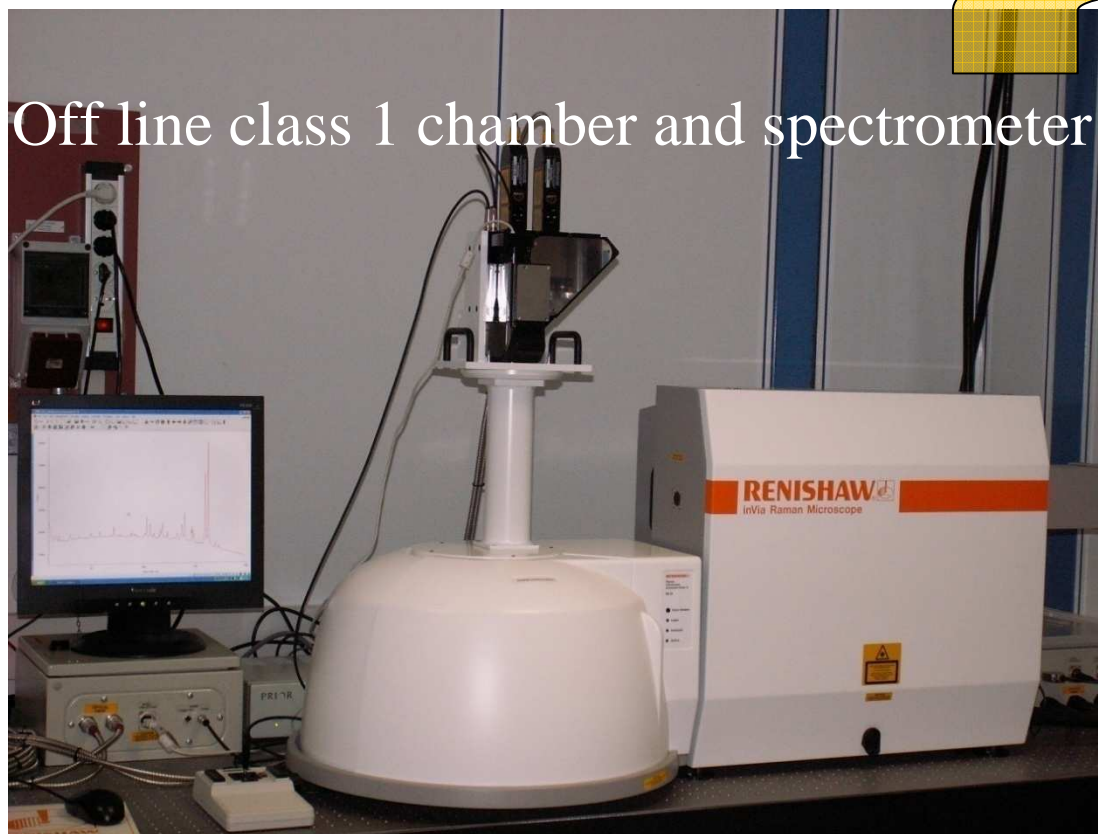

Two way optical fibres (laser and Raman signal back) to both x-ray stations

Fibre optic vs. two-windows cell

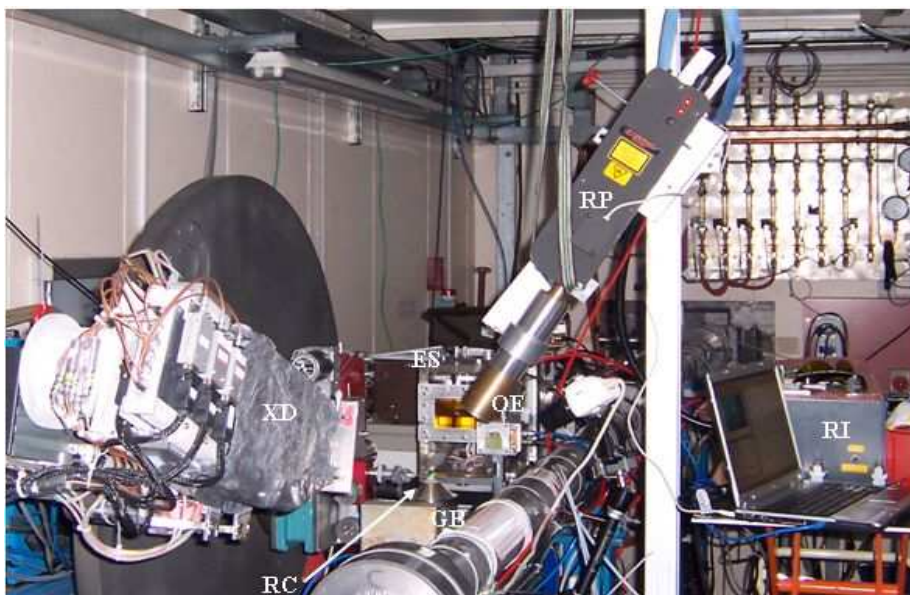

Optical fibres approach allows to leave the XRPD setup and sample holder unchanged

If fibres are not used, a special sample holder with two windows must be designed and most often is no more optimized for XRPD (see XRPD/UV-Vis)

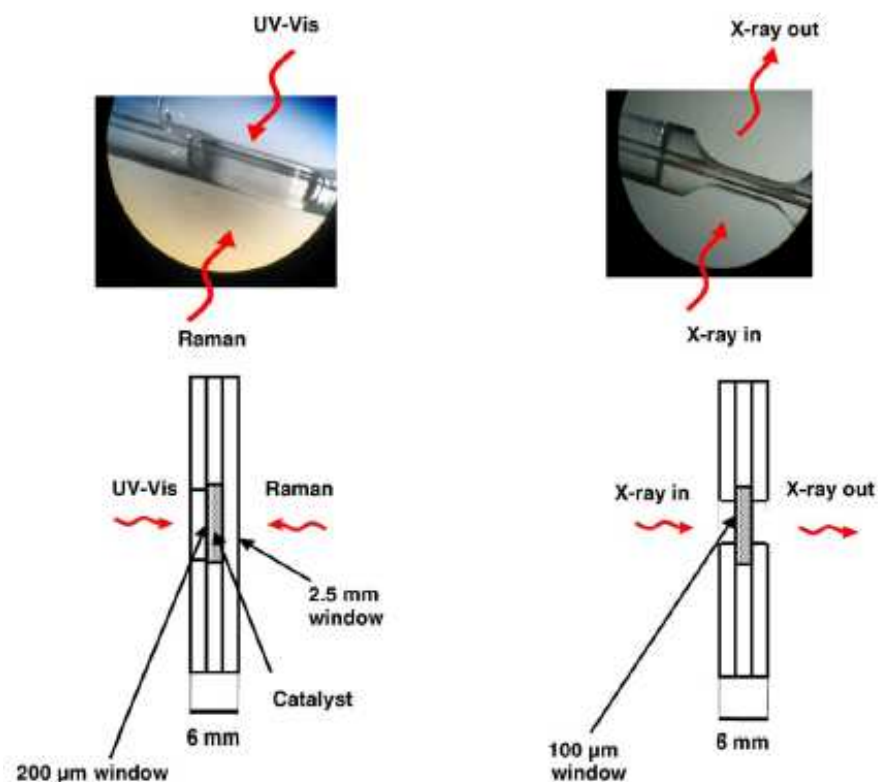

Other technique can give complementary information: the case of Raman spectroscopy

Raman spectroscopy can give complementary information to XRPD, being extremely sensitive to small structural distortions, to changes in the hydration/protonation states, to surface modifications and to changes in the charge/defect distribution and short-range ordering.



Chandrasekhar Venkata Raman
(1888-1970)

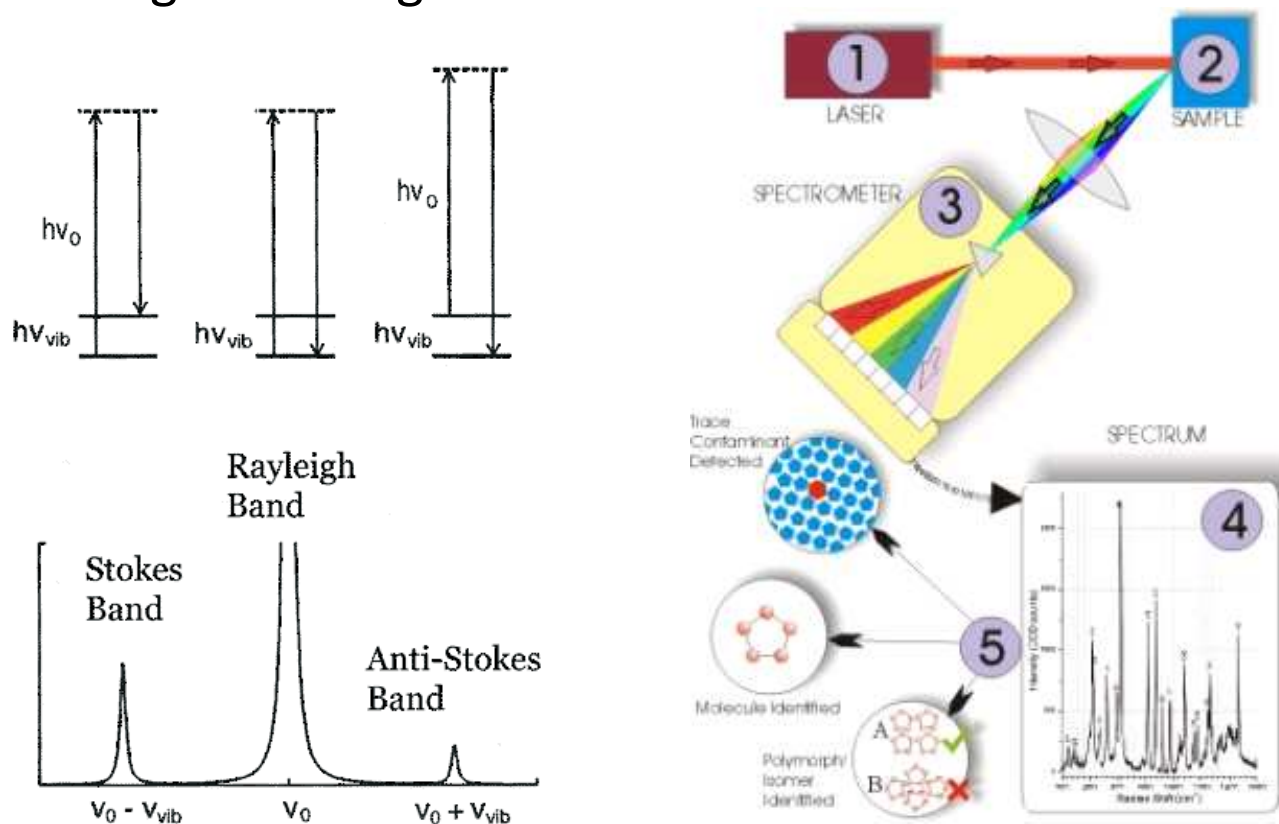

The choice of the Raman – NIR or visible?

NIR laser features

Advantages:

-) “Bulk-probe”
-) No or reduced fluorescence

Drawbacks:

-) limited to 350 K because of the blackbody radiation
-) safety issue (class 4) → complex implementation in the beamline

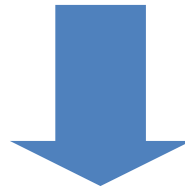

Visible lasers (532 and 785 nm)

-) Easy interchange of the lasers with a single spectrometer
-) Black body radiation problems usually above 700 K
-) Fluorescence can be minimized by choosing the laser
-) Faster Raman probe → good for in situ experiment

The choice of the Laser – 532 or 758 nm?

Green 532 nm laser

Advantages:

-) Often surface sensitivity enhanced
-) higher T limit for the blackbody radiation
-) *Apt to investigate surface reactivity*

Drawbacks:

-) Fluorescence
-) Smaller S/N

Red 785 nm laser

Advantages:

-) Less fluorescence
-) higher Raman signal
-) *Apt to investigate disordered/light atoms moieties*

Drawbacks:

-) Smaller surface sensitivity
-) Blackbody radiation problem at $< T$



Advantages

The sample is studied with two probes

- 1) During its formation/production
- 2) In the operating condition
- 3) In relation with its stability in different conditions
- 4) Finding/controlling the degradation pathways
- 5) Analyzing problems related to disposal/recycling

The sample properties are measured **directly while the fundamental phenomena affecting the sample properties occur**

TOOLS needed:

Sample environment to treat the sample

Fast detectors to follow the transformations

Spatial and temporal synchronization of the two probes



Main advantage

Perfect synchronization of the two probes with the reaction coordinate and the elimination of any possible bias caused by different sample holders and conditioning modes used in “in situ but separate” approaches.

The simultaneous approach is also more time efficient compared to two separated in situ experiments (after setting up the multi-technique setup)

van Beek et al., Phase Transition, 2009 , 82(4), 293 – 302

..... and drawbacks

- 1) Data resolution is limited by the limited time of data collection
- 2) Statistic and S/N ratio are reduced
- 3) 2θ limitations are often imposed by sample environment
- 4) The experiment is more complex from the execution viewpoint



Blower is needed
Rotation hindered by gas
flow system/sample
environment, additional
probe, special reaction
chamber
.....???

...more problem in simultaneous experiments

Information obtained for a system can be biased by

- i) Different concentrations in the sample holder
- ii) Capillary confinement effect (reactant/product diffusion)
- iii) Sample heated/cooled only partially (gas blower)
- iv) Spatial synchronization (same spot, same size?)
- v) Time synchronization (same data collection time?)
- vi)???

van Beek et al., Phase Transition, 2009, 2009, 82(4), 293

Experimental setup – *Selection and Tips&Tricks*

Select the best experimental setup depending on sample features, needed information, scientific problem....

Flat sample or capillary geometry?

Lab or synchrotron?

In situ conditions reproduce correctly real reaction?

i.e. scale up from capillary to lab reactor to industrial plant work? Example: studying cement reactions

Time resolution is consistent with reaction rate?

Not useful going to synchrotron to study a reaction lasting hours/days

If you go to synchrotron carry out the reaction in the lab in your diffractometer and/or ex situ in the

...

Possible multi-technique experiments at the SNBL...

Raman/XRPD/Mass Spectroscopy

Raman/EXAFS/Mass Spectroscopy

Raman/XRPD/EXAFS

Raman/XRPD/XAFS/Mass Spectroscopy

Raman/Single crystal XRD

..... accessible non ambient conditions

Gas blower + Cryostream nitrogen blower:

from 80 to 1300 K

Helium cryostat → **down to 4 K**

Gas pumping system: from vacuum to 30 bars

Diamond Anvil cell: from 0 to 50 GP

Lamp- and laser- induced excitation:

photo-reactivity

Summary

Limitation (and possibilities) of (SR) powder diffraction
Definition of “in situ experiments”

PART I: Possible combination “*ex situ separated approach*”, XRPD & NMR ; XRPD & HR-TEM →
structure solution and refinement

Theoretical calculations → better structural models

PART II: Possible *combination at in situ conditions at the synchrotron*: XRPD & DSC, XRPD & Raman, XRPD & IR, XRPD-UV-Vis, XRPD-MS

PART III examples with Raman/XRPD

PART III

A case study with the XRPD & Raman spectroscopy at the SNBL (ESRF, Grenoble)

Complementary information by Raman spectroscopy:

- Information on molecular structure: single and double bonds, molecular groups, organic molecules structure etc
- Information at the interaction level
- ***“Surface” sensitivity***
- Information on light atoms
- Information of disordered, amorphous, gel, liquid phases

Fluorene:TCNQ solid-state synthesis

Co-crystalline complexes between **fluorene** and **electron withdrawing compounds** are usually synthesized by **dissolution** of the reactants in a polar solvent (Arrais A. et al., CrystEngComm, 5, 2003, 388).

Class of compounds interesting because the **optical properties** of fluorene may be **tuned** by choosing **different counterparts**.

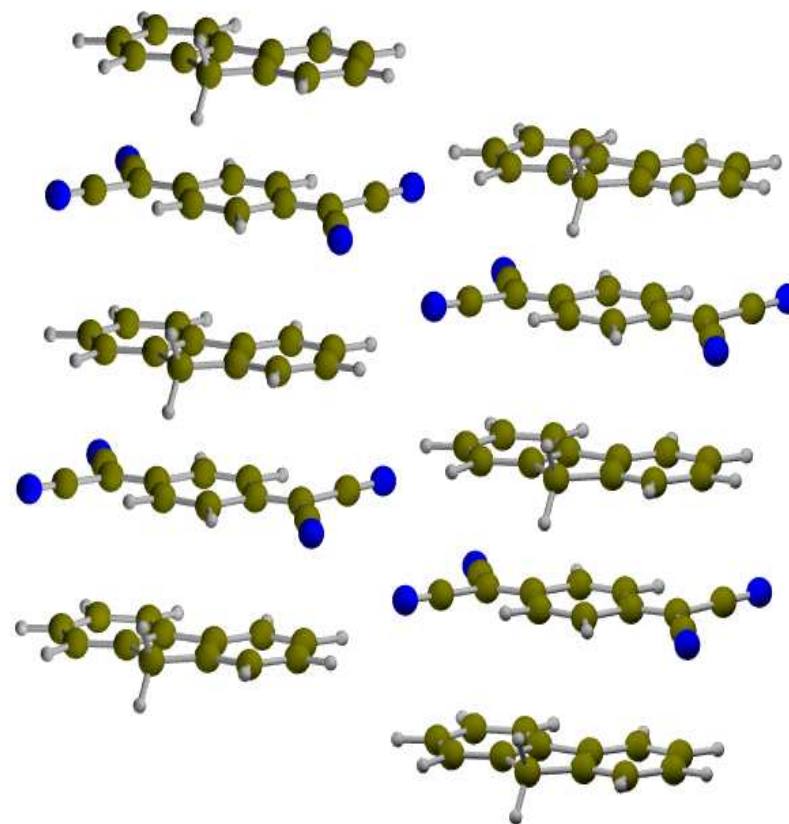

The fluorene:TCNQ complex has been recently obtained by direct solid-state synthesis

Method: The fluorene/7,7,8,8-tetracyanoquinodimethane (TCNQ) molecular complex was obtained for the first time via **solid-state synthesis**, by heating the reactants in a sealed glass capillary.

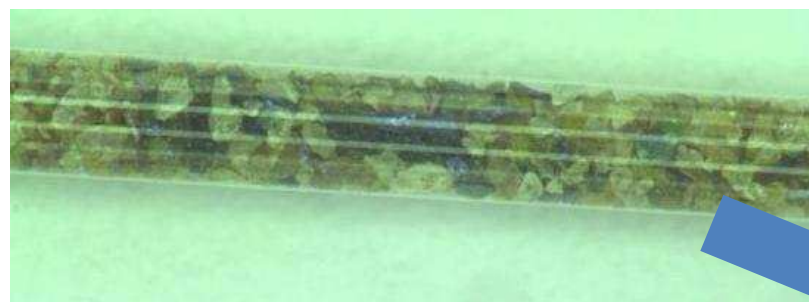

Before reaction

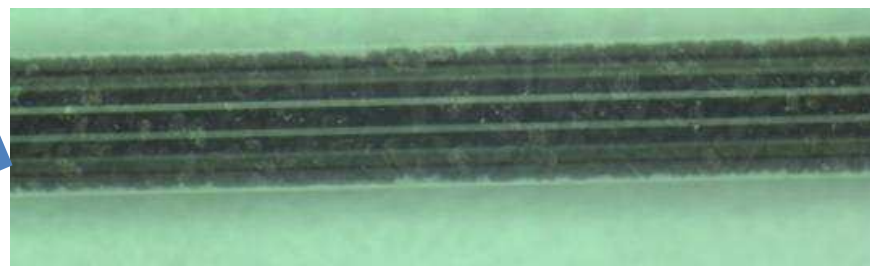

After reaction at 360K

Advantages of solid-state synthesis: i) reduction of synthesis costs, ii) no pollution from gas/liquid byproducts, iii) a much simpler reaction chamber, iv) yield close to 100%.

The reaction coordinate in the bulk (X-ray)

Rietveld refinement and Quantitative analysis: the variations of the product mole fractions at 348, 358, 368 and 378 K.

Reaction coordinate in the bulk (α): calculated as a ratio between the moles of product (fluorene:TCNQ complex) at each scan ($Moles_i$) and the moles of TCNQ available at the beginning of the reaction ($Moles_0$):

$$\alpha = \frac{Moles_i}{Moles_0}$$

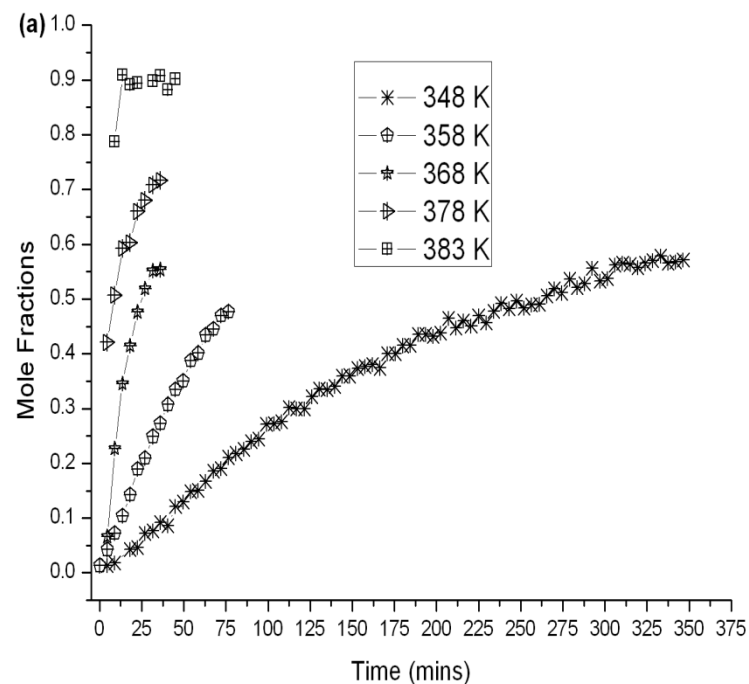

The reaction coordinate at the surface (Raman)

Raman peak area analysis:
variation of the integrated intensity of the band due to ring deformation at 1600 cm^{-1} in the reactant and in the product at different T.

Reaction coordinate at the “surface”
calculated as ratio between the area of the Raman peak of TCNQ in the product at each scan (TCNQ_i) and the area of the TCNQ peak at the beginning (TCNQ_0):

$$\alpha = \frac{\text{TCNQ}_i}{\text{TCNQ}_0}$$

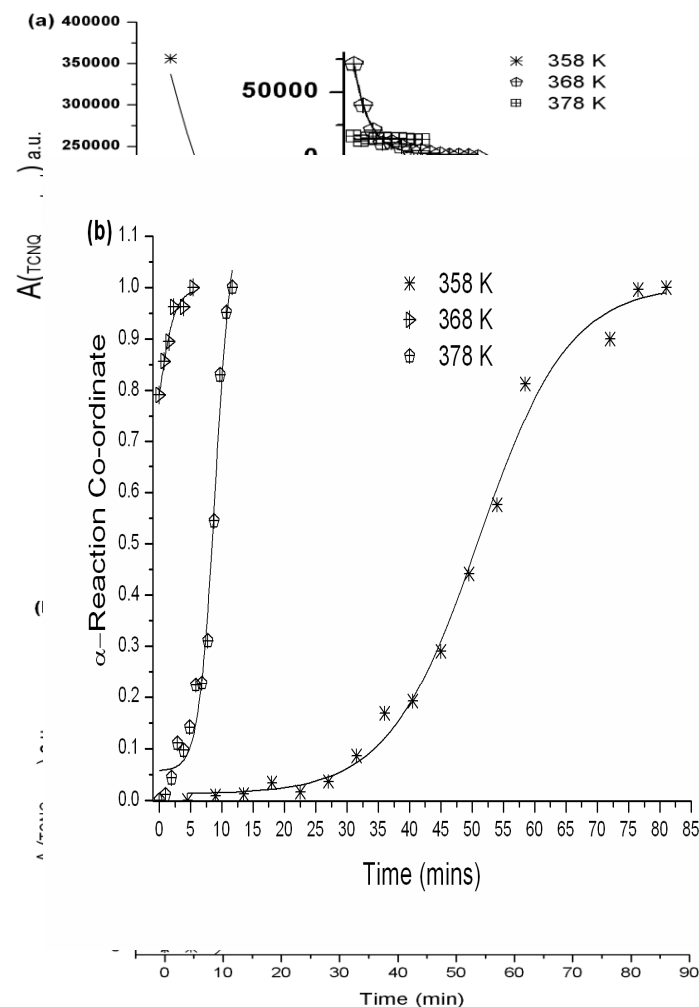

The kinetic model for the solid-state reaction

Sublimation of Fluorene

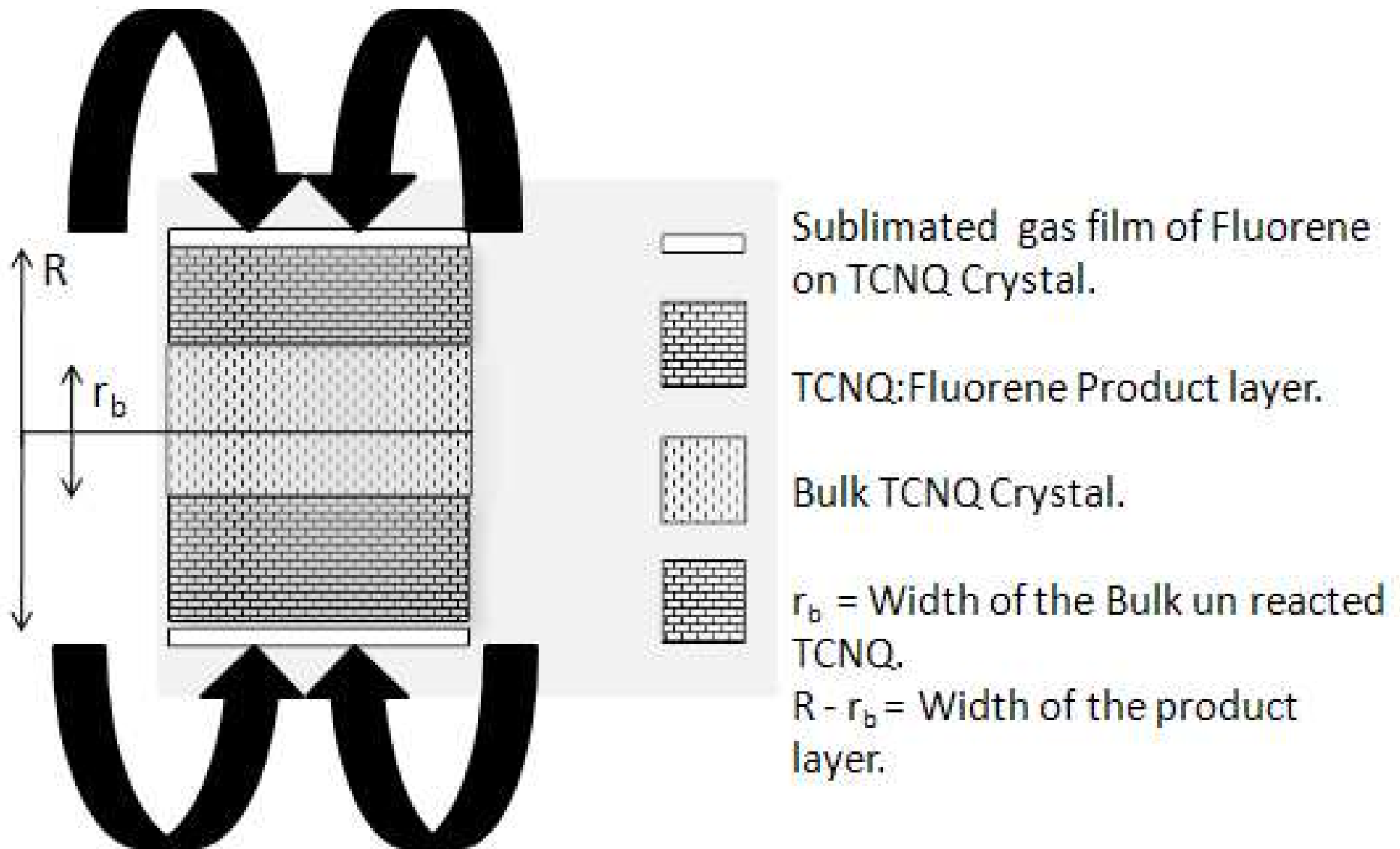

Sublimation of Fluorene

Hot stage microscopy – the smoking gun!

TCNQ crystal at RT



TCNQ crystal exposed to fluorene vapors at 400 K after one minute



TCNQ crystal exposed to fluorene vapors at 400 K after about 10 minutes

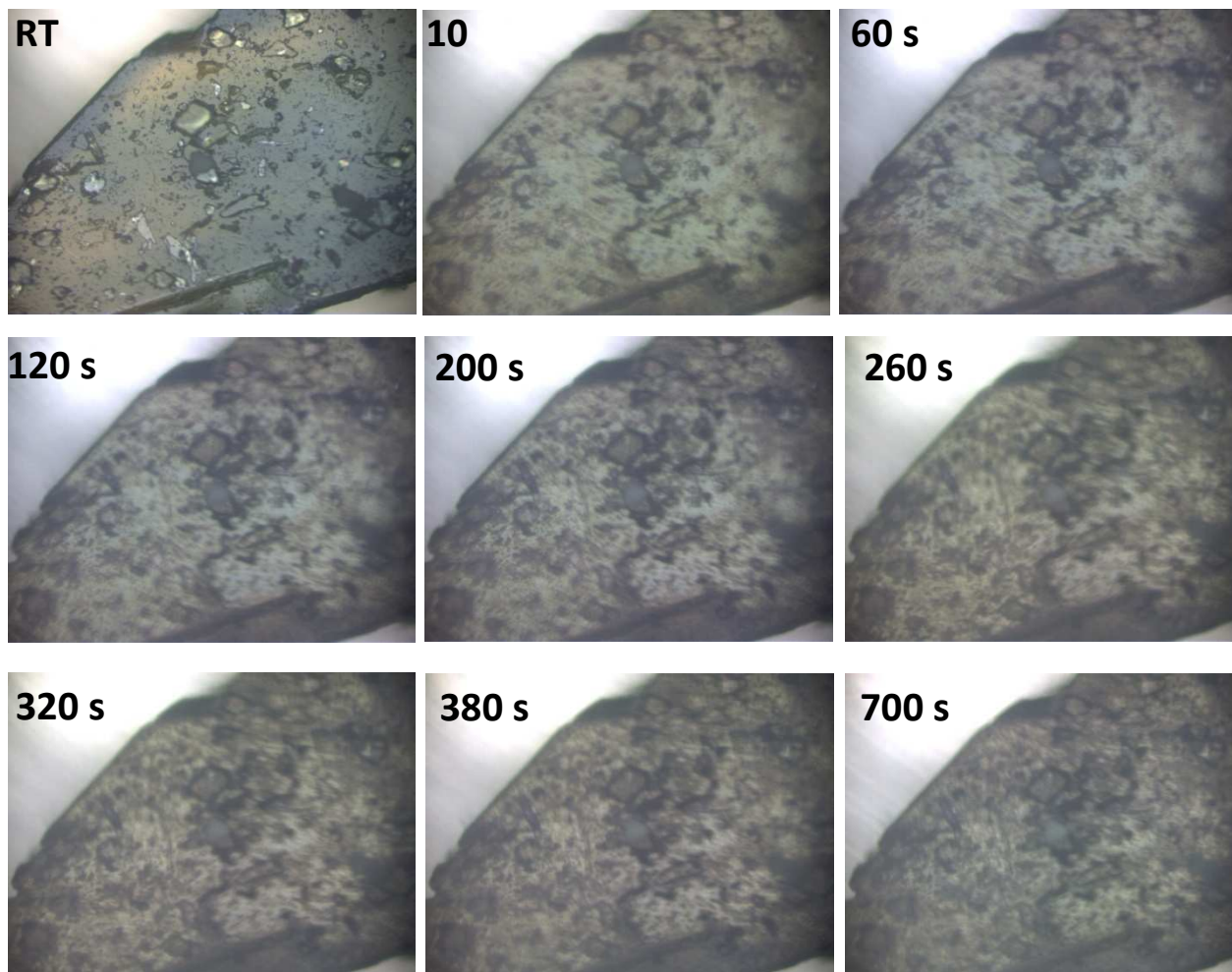

Kumar et al., *Crystal Growth and Design*, **2009**, 9(8), 3396

Case study 2: the photoinduced 2+2 cyclization of (E)-furylidenoxindole

*Solid-state UV Light induced dimerization →
ciclobutane formation*

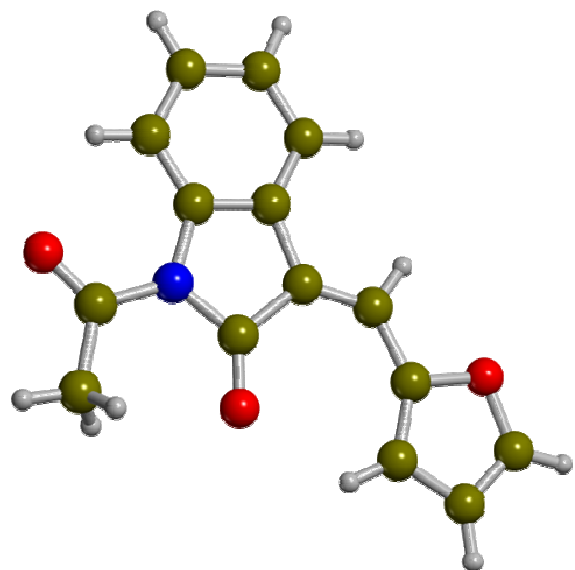

Monomer

$h\nu$ (~300nm)

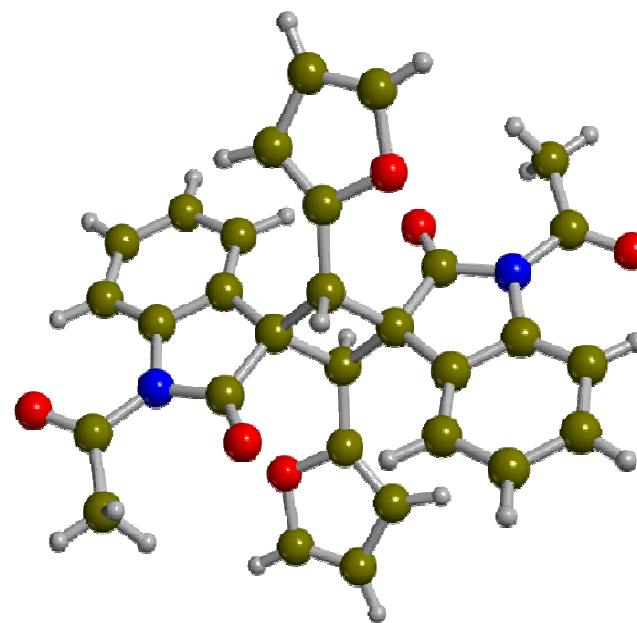
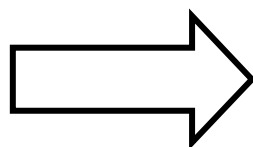

Dimer

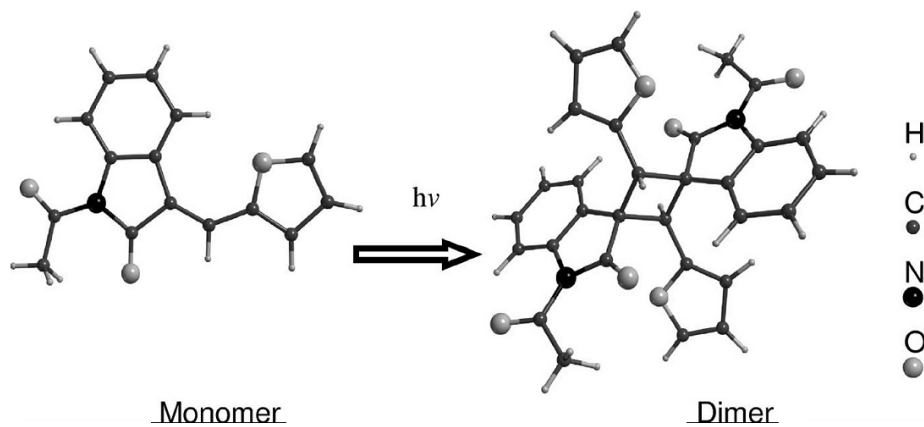

The Raman spectra clearly highlighted the rapid exponential disappearance of the features of the monomer fingerprints,

C=C stretching mode, centered at 1610 cm^{-1}
 C=C-H scissoring modes at $1460\text{-}1440\text{ cm}^{-1}$

the parallel formation of the "dimer" pattern
 the typical bands at 1350 and 1303 cm^{-1} ,
 corresponding to cyclobutane C-C-H bendings

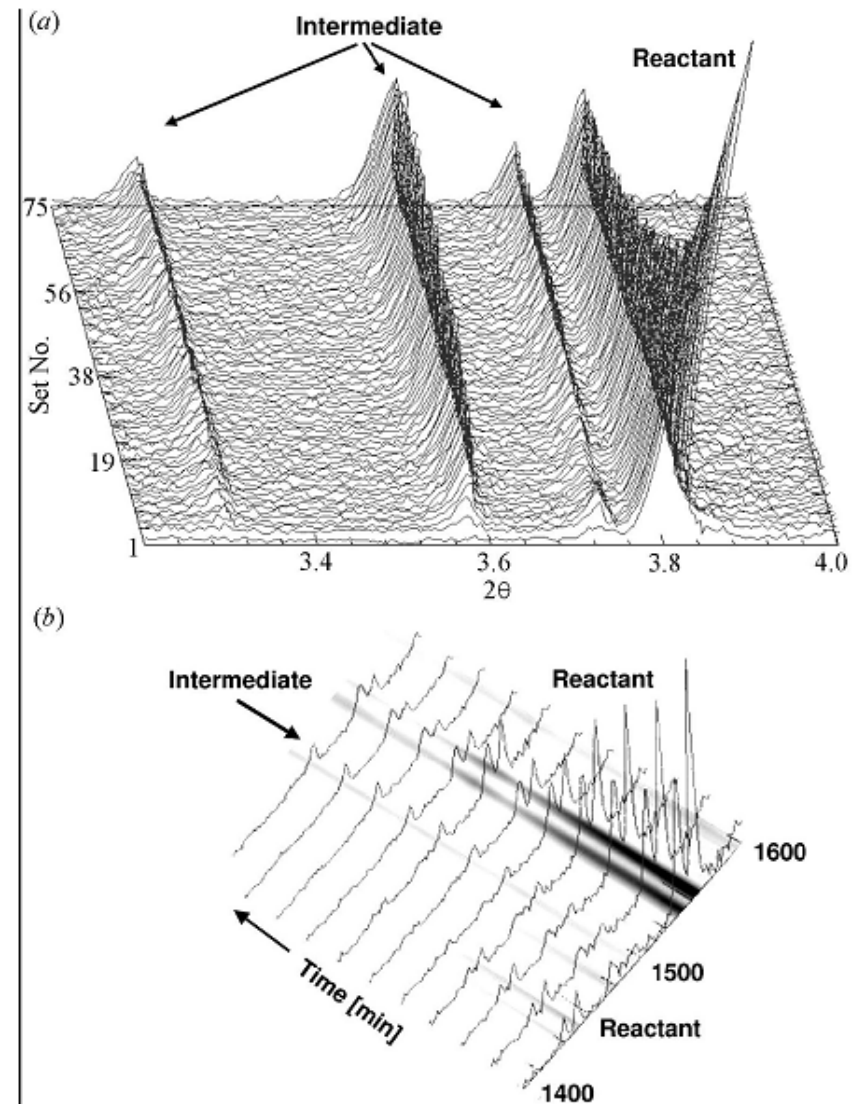

Acknowledgments

- ✓ **Davide Viterbo, Leonardo Marchese, Gianluca Croce, Sumeet Kumar, Aldo Arrais, Fabio Carniato, Enrico Boccaleri, Luca Palin, Sarah Ferretti** of Università del Piemonte Orientale, Alessandria, Italy
- ✓ **Heloise H. Pastore** of University of Campinas, Brasil
- ✓ **Wouter van Beek and Hermann Emerich** of *Swiss-Norwegian Beamlines (SNBL)*, ESRF, Grenoble, France
- ✓ **Michel Belleil** and **Tim Smith** of Renishaw for their assistance during the Raman installation
- ✓ **ESRF** and **SNBL** (Grenoble, France) for a **long-term project** on “The implementation of a simultaneous Raman/<high resolution X-ray diffraction> or absorption approach for the in situ investigation of solid state transformations”
- ✓ **Serena Margadonna** (University of Edinburgh, Scotland), **Dewi Lewis** (University College London), **Mark Green** (NIST, Gaithersburg, USA), **Gopinathan Sankar** (Davy Faraday Research Laboratory, London, UK), **Jens Kreisel** (CNRS, Grenoble, France) for the collaboration in the **Long Term Project**

Enjoy with in situ simultaneous
multitechnique experiments



✓ and all of you for your
kind attention!



To boldly go where *no one* has gone
beforewith ??????/XRPD